

SATELLITE COMMUNICATION

www.EnggTree.com

UNIT I SATELLITE ORBITS

UNIT I SATELLITE ORBITS

AIM & OBJECTIVE

- ❖ To understand the basics of satellite orbits.
- ❖ To analyze the geo stationary and non geo stationary orbits.
- ❖ To acquire the knowledge about launching procedures.

PRE-TEST MCQ

1. A television (TV) transmission is an example of which type of transmission?

- a) Simplex**
- b) Half duplex
- c) Full duplex
- d) None of the above

www.EnggTree.com

2. What is application of satellite systems?

- a) Weather forecasting**
- b) Terrestrial communication
- c) point to point communication
- d) None of the above

3. The down link frequency in the C band transponder is

- (a) 6 GHz
- (b) 4 GHz**
- (c) 14 GHz
- (d) 11 GHz

THEORY

1.1 Introduction to satellite communication

Satellites are specifically made for telecommunication purpose. They are used for mobile applications such as communication to ships, vehicles, planes, hand-held terminals and for TV and radio broadcasting.

They are responsible for providing these services to an assigned region (area) on the earth. The power and bandwidth of these satellites depend upon the preferred size of the footprint, complexity of the traffic control protocol schemes and the cost of ground stations.

A satellite works most efficiently when the transmissions are focused with a desired area.

When the area is focused, then the emissions don't go outside that designated area and thus minimizing the interference to the other systems. This leads more efficient spectrum usage.

Satellites antenna patterns play an important role and must be designed to best cover the designated geographical area (which is generally irregular in shape).

Satellites should be designed by keeping in mind its usability for short and long term effects throughout its life time.

The earth station should be in a position to control the satellite if it drifts from its orbit it is subjected to any kind of drag from the external forces.

Applications of Satellites:

- ❖ Weather Forecasting
- ❖ Radio and TV Broadcast
- ❖ Military Satellites
- ❖ Navigation Satellites
- ❖ Global Telephone
- ❖ Connecting Remote Area
- ❖ Global Mobile Communication

1.2 Kepler's laws

1.2.1 Kepler's law Introduction

Satellites (spacecraft) orbiting the earth follow the same laws that govern the motion of the planets around the sun.

Kepler's laws apply quite generally to any two bodies in space which interact through gravitation. The more massive of the two bodies is referred to as the *primary*, the other, the *secondary* or *satellite*.

1.2.2 Kepler's First Law

Kepler's first law states that the path followed by a satellite around the primary will be an ellipse. An ellipse has two focal points shown as F_1 and F_2 in Fig. 2.1. The center of mass of the two-body system, termed the *bary center*, is always center of the foci.

The semi major axis of the ellipse is denoted by a , and the semi minor axis, by b . The eccentricity e is given by

$$e = \frac{\sqrt{a^2 - b^2}}{a}$$

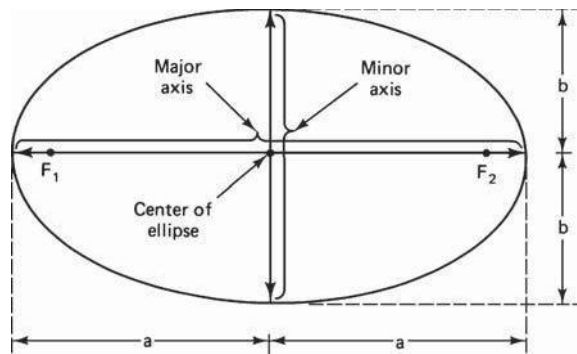

Figure 1.1 The foci F_1 and F_2 , the semi major axis a , and the semi minor axis b of an ellipse.

1.2.3 Kepler's Second Law

Kepler's second law states that, for equal time intervals, a satellite will sweep out equal areas in its orbital plane, focused at the barycenter. Referring to Fig. 2.2, assuming the satellite travels distances S_1 and S_2 meters in 1 s, then the areas A_1 and A_2 will be equal. The average velocity in each case is S_1 and S_2 m/s, and because of the equal area law, it follows that the velocity at S_2 is less than that at S_1 .

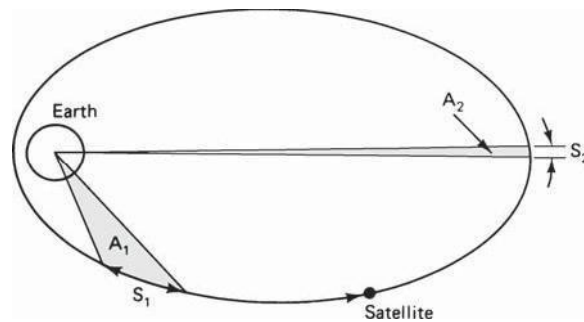

Figure 1.2 Kepler's second law. The areas A_1 and A_2 swept out in unit time are equal.

1.2.4 Kepler's Third Law

Kepler's third law states that the square of the periodic time of orbit is proportional to the cube of the mean distance between the two bodies. The mean distance is equal to the semi major axis a .

For the artificial satellites orbiting the earth, Kepler's third law can be written in the form

$$a^3 = \mu / n^2$$

Where n is the mean motion of the satellite in radians per second and μ is the earth's geocentric gravitational constant $\mu = 3.986005 \times 10^{14} \text{ m}^3/\text{s}^2$

1.3. Newton's law:

1.3.1 Newton's first law

An object at rest will remain at rest unless acted on by an unbalanced force. An object in motion continues in motion with the same speed and in the same direction unless acted upon by an unbalanced force. This law is often called "**the law of inertia**".

1.3.2 Newton's second law

Acceleration is produced when a force acts on a mass. The greater the mass (of the object being accelerated) the greater the amount of force needed (to accelerate the object).

1.3.3 Newton's first law

For every action there is an equal and opposite re-action. This means that for every force there is a reaction force that is equal in size, but opposite in direction. That is to say that whenever an object pushes another object it gets pushed back in the opposite direction equally hard.

1.4. orbital parameters

Apogee: A point for a satellite farthest from the Earth. It is denoted as **ha**.

Perigee: A point for a satellite closest from the Earth. It is denoted as **hp**.

Line of Apsides: Line joining perigee and apogee through centre of the Earth. It is the major axis of the orbit. One-half of this line's length is the semi-major axis equivalent to satellite's mean distance from the Earth.

Ascending Node: The point where the orbit crosses the equatorial plane going from north to south.

Descending Node: The point where the orbit crosses the equatorial plane going from south to north.

Inclination: the angle between the orbital plane and the Earth's equatorial plane. Its measured at the ascending node from the equator to the orbit, going from East to North. Also, this angle is commonly denoted as **i**.

www.EnggTree.com

Line of Nodes: the line joining the ascending and descending nodes through the centre of Earth.

Prograde Orbit: an orbit in which satellite moves in the same direction as the Earth's rotation. Its inclination is always between 00 to 900. Many satellites follow this path as Earth's velocity makes it easier to launch these satellites.

Retrograde Orbit: an orbit in which satellite moves in the same direction counter to the Earth's rotation.

Argument of Perigee: An angle from the point of perigee measure in the orbital plane at the Earth's centre, in the direction of the satellite motion.

Right ascension of ascending node: The definition of an orbit in space, the position of ascending node is specified. But as the Earth spins, the longitude of ascending node changes and cannot be used for reference. Thus for practical determination of an orbit, the longitude and time of crossing the ascending node is used. For absolute measurement, a fixed reference point in space is required.

It could also be defined as “*right ascension of the ascending node; right ascension is the angular position measured eastward along the celestial equator from the vernal equinox vector to the hour circle of the object*”.

Mean anomaly: It gives the average value to the angular position of the satellite with reference to the perigee.

True anomaly: It is the angle from perigee to the satellite’s position, the angle from point of measure at the Earth’s centre.

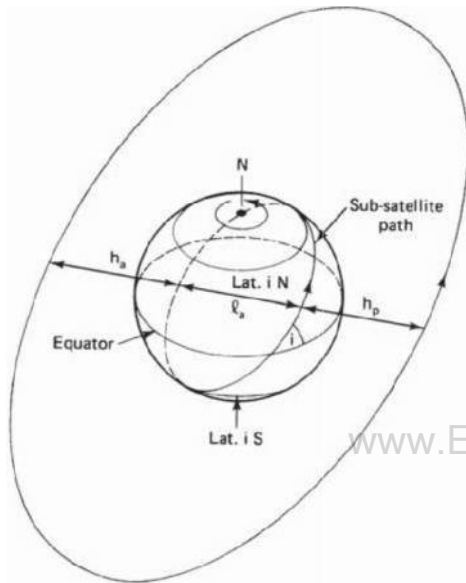

Figure 1.2 Apogee height h_a , perigee height h_p , and inclination i . LQ is the line of apsides.

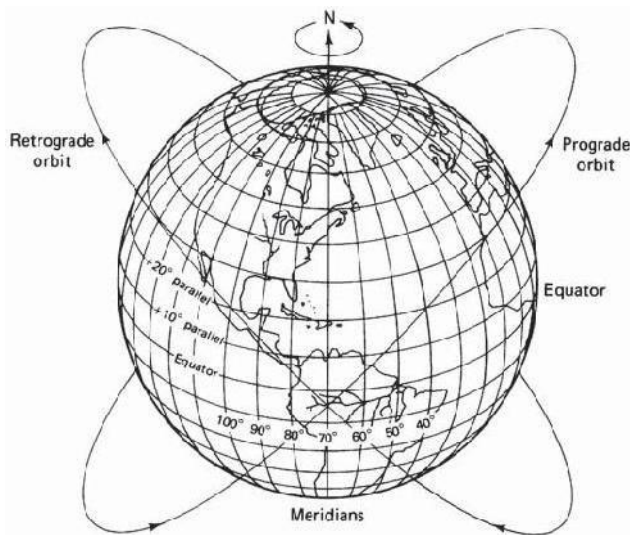

Figure 1.3(a) Prograde and retrograde orbits.

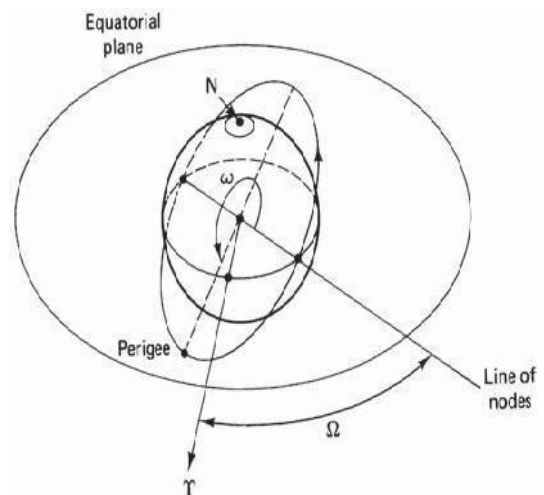

Figure 1.4 The argument of perigee ω & right ascension of the ascending node Ω .

1.5. Orbital Perturbations

Theoretically, an orbit described by Kepler is ideal as Earth is considered to be a perfect sphere and the force acting around the Earth is the centrifugal force. This force is supposed to balance the gravitational pull of the earth.

In reality, other forces also play an important role and affect the motion of the satellite. These forces are the gravitational forces of Sun and Moon along with the atmospheric drag.

Effect of Sun and Moon is more pronounced on geostationary earth satellites where as the atmospheric drag effect is more pronounced for low earth orbit satellites.

1.5.1 Effects of non-Spherical Earth

As the shape of Earth is not a perfect sphere, it causes some variations in the path followed by the satellites around the primary. As the Earth is bulging from the equatorial belt, and keeping in mind that an orbit is not a physical entity, and it is the forces resulting from an oblate Earth which act on the satellite produce a change in the orbital parameters.

This causes the satellite to drift as a result of regression of the nodes and the latitude of the point of perigee (point closest to the Earth). This leads to rotation of the line of apsides. As the orbit itself is moving with respect to the Earth, the resultant changes are seen in the values of argument of perigee and right ascension of ascending node.

Due to the non-spherical shape of Earth, one more effect called as the "Satellite Graveyard" is seen. The non-spherical shape leads to the small value of eccentricity (10⁻⁵) at the equatorial plane. This causes a gravity gradient on GEO satellite and makes them drift to one of the two stable points which coincide with minor axis of the equatorial ellipse.

1.5.2 Atmospheric Drag

For Low Earth orbiting satellites, the effect of atmospheric drag is more pronounced. The impact of this drag is maximum at the point of perigee. Drag (pull towards the Earth) has an effect on velocity of Satellite (velocity reduces).

This causes the satellite to not reach the apogee height successive revolutions. This leads to a change in value of semi-major axis and eccentricity. Satellites in service are maneuvered by the earth station back to their original orbital position.

1.6 Station Keeping

In addition to having its attitude controlled, it is important that a geostationary satellite be kept in its correct orbital slot. The equatorial ellipticity of the earth causes geostationary satellites to drift slowly along the orbit, to one of two stable points, at 75°E and 105°W .

To counter this drift, an oppositely directed velocity component is imparted to the satellite by means of jets, which are pulsed once every 2 or 3 weeks.

These maneuvers are termed *east-west station-keeping maneuvers*. Satellites in the 6/4-GHz band must be kept within 0.1° of the designated longitude, and in the 14/12-GHz band, within 0.05° .

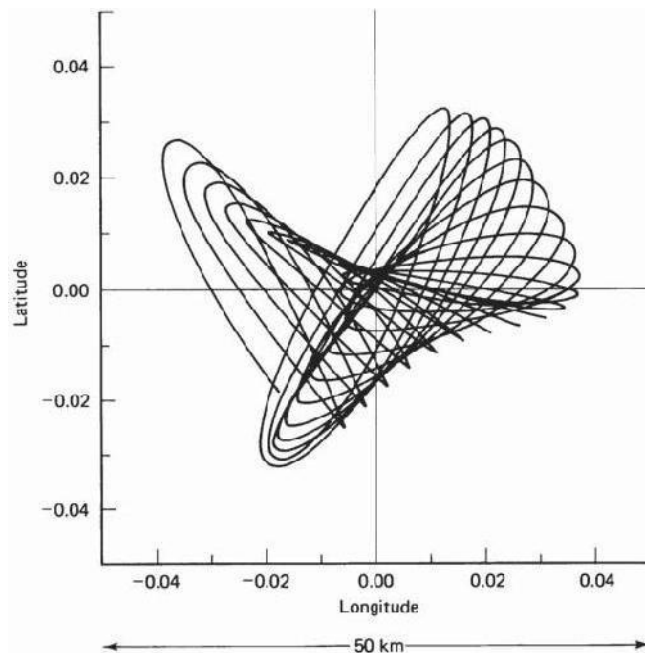

Figure 1.5 Typical satellite motion. (Courtesy of Telesat, Canada, 1983.)

1.7. Geo stationary and Non Geo-stationary orbits

1.7.1 Geo stationary

A **geostationary** orbit is one in which a satellite orbits the earth at exactly the same speed as the earth turns and at the same latitude, specifically zero, the latitude of the equator. A satellite orbiting in a geostationary orbit appears to be hovering in the same spot in the sky, and is directly over the same patch of ground at all times.

A **geosynchronous** orbit is one in which the satellite is synchronized with the earth's rotation, but the orbit is tilted with respect to the plane of the equator. A satellite in a geosynchronous orbit will wander up and down in latitude, although it will stay over the same line of longitude. Although the terms 'geostationary' and 'geosynchronous' are sometimes used interchangeably, they are not the same technically; geostationary orbit is a subset of all possible geosynchronous orbits.

The person most widely credited with developing the concept of geostationary orbits is noted science fiction author Arthur C. Clarke (Islands in the Sky, Childhood's End, Rendezvous with Rama, and the movie 2001: a Space Odyssey). Others had earlier pointed out that bodies traveling a certain distance above the earth on the equatorial plane would remain motionless with respect to the earth's surface. But Clarke published an article in 1945's Wireless World that made the leap from the Germans' rocket research to suggest permanent manmade satellites that could serve as communication relays.

Geostationary objects in orbit must be at a certain distance above the earth; any closer and the orbit would decay, and farther out they would escape the earth's gravity altogether. This distance is 35,786 kilometers (22,236 miles) from the surface.

The first geosynchronous satellite was orbited in 1963, and the first geostationary one the following year. Since the only geostationary orbit is in a plane with the equator at 35,786 kilometers, there is only one circle around the world where these conditions obtain.

This means that geostationary 'real estate' is finite. While satellites are in no danger of bumping in to one another yet, they must be spaced around the circle so that their frequencies do not interfere with the functioning of their nearest neighbors.

Geostationary Satellites

There are 2 kinds of manmade satellites in the heavens above: One kind of satellite ORBITS the earth once or twice a day, and the other kind is called a communications satellite and it is PARKED in a STATIONARY position 22,300 miles (35,900 km) above the equator of the STATIONARY earth.

A type of the orbiting satellite includes the space shuttle and the international space station which keep a low earth orbit (LEO) to avoid the deadly Van Allen radiation belts.

The most prominent satellites in medium earth orbit (MEO) are the satellites which comprise the GLOBAL POSITIONING SYSTEM or GPS as it is called.

The Global Positioning System

www.EnggTree.com

The global positioning system was developed by the U.S. military and then opened to civilian use. It is used today to track planes, ships, trains, cars or literally anything that moves. Anyone can buy a receiver and track their exact location by using a GPS receiver.



GPS satellites orbit at a height of about 12,000 miles (19,300 km) and orbit the earth once every 12 hours.

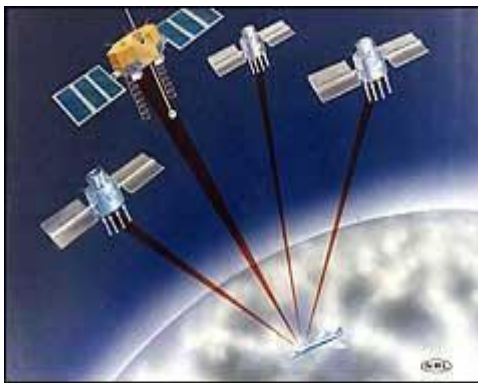

About 24 GPS satellites orbit the earth every 12 hours.

These satellites are traveling around the earth at speeds of about 7,000 mph (11,200 kph). GPS satellites are powered by solar energy. They have backup batteries onboard to keep them running in the event of a solar eclipse, when there's no solar power.

Small rocket boosters on each satellite keep them flying in the correct path. The satellites have a lifetime of about 10 years until all their fuel runs out.

At exactly 22,300 miles above the equator, the force of gravity is cancelled by the centrifugal force of the rotating universe. This is the ideal spot to park a stationary satellite.

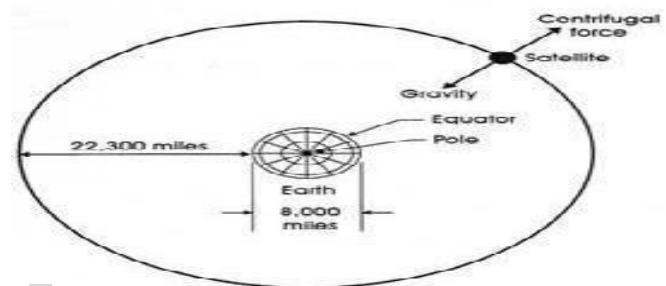
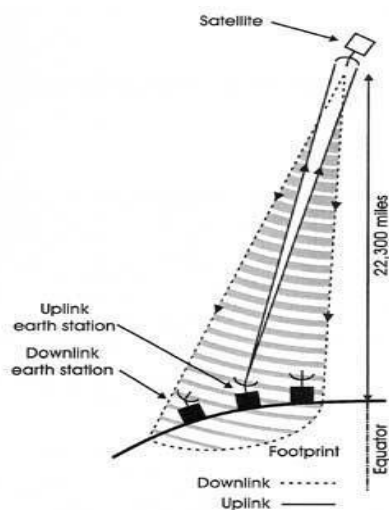

www.EnggTree.com

Figure. 1.6 & 1.7 At exactly 22,000 miles (35,900 km) above the equator, the earth's force of gravity is canceled by the centrifugal force of the rotating universe. .

1.7.2 Non Geo-Stationary Orbit

For the geo-stationary case, the most important of these are the gravitational fields of the moon and the sun, and the nonspherical shape of the earth.

Other significant forces are solar radiation pressure and reaction of the satellite itself to motor movement within the satellite. As a result, station-keeping maneuvers must be carried out to maintain the satellite within set limits of its nominal geostationary position.

An exact geostationary orbit therefore is not attainable in practice, and the orbital parameters vary with time. The two-line orbital elements are published at regular intervals.

The period for a geostationary satellite is 23 h, 56 min, 4 s, or 86,164 s. The reciprocal of this is 1.00273896 rev/day, which is about the value tabulated for most of the satellites in Fig.

Thus these satellites are *geo-synchronous*, in that they rotate in synchronism with the rotation of the earth. However, they are not geostationary. The term *geosynchronous satellite* is used in many cases instead of *geostationary* to describe these near-geostationary satellites.

It should be noted, however, that in general a geosynchronous satellite does not have to be near-geostationary, and there are a number of geosynchronous satellites that are in highly elliptical orbits with comparatively large inclinations (e.g., the Tundra satellites).

The small inclination makes it difficult to locate the position of the ascending node, and the small eccentricity makes it difficult to locate the position of the perigee.

However, because of the small inclination, the angles w and Ω can be assumed to be in the same plane. The longitude of the subsatellite point (the satellite longitude) is the east early rotation from the Greenwich meridian.

$$\phi_{SS} = \omega + \Omega + v - \text{GST}$$

The *Greenwich sidereal time* (GST) gives the eastward position of the Greenwich meridian relative to the line of Aries, and hence the subsatellite point is at longitude and the mean longitude of the satellite is given by

$$\phi_{SS\text{mean}} = \omega + \Omega + M - \text{GST}$$

Equation(2.31) can be used to calculate the true anomaly, and because of the small eccentricity, this can be approximated as $v = M + 2e \sin M$.

1.8 Look Angle Determination

The look angles for the ground station antenna are Azimuth and Elevation angles. They are required at the antenna so that it points directly at the satellite. Look angles are calculated by considering the elliptical orbit. These angles change in order to track the satellite.

For geostationary orbit, these angles values does not change as the satellites are stationary with respect to earth. Thus large earth stations are used for commercial communications.

For home antennas, antenna beamwidth is quite broad and hence no tracking is essential. This leads to a fixed position for these antennas.

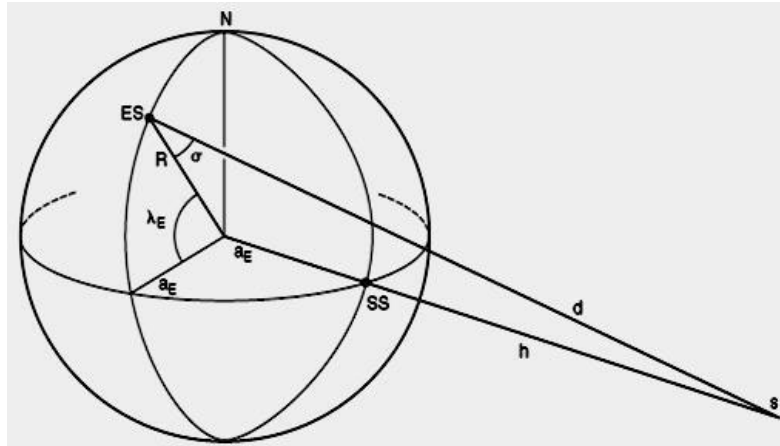

Figure 1.8: The geometry used in determining the look angles for

Geostationary

www.Satellites.com

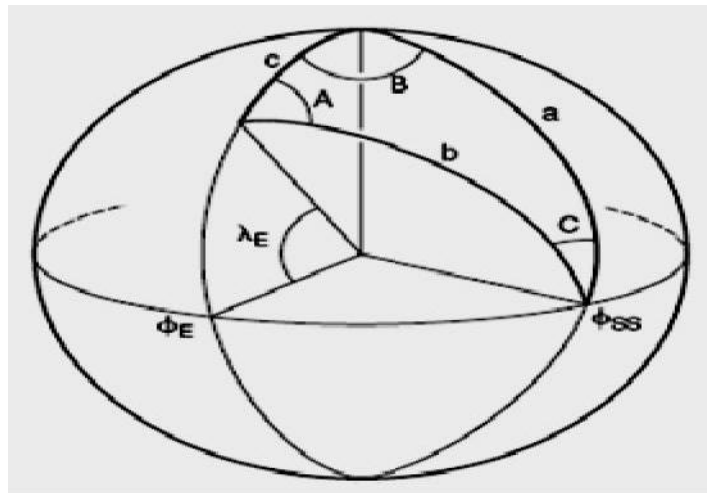

Figure 1.9: The spherical geometry related to figure 1.8

With respect to the figure 1.8 and 1.9, the following information is needed to determine the look angles of geostationary orbit.

1. Earth Station Latitude: λ_E
2. Earth Station Longitude: Φ_E

3. Sub-Satellite Point's Longitude: Φ_{SS}
4. ES: Position of Earth Station
5. SS: Sub-Satellite Point
6. S: Satellite
7. d : Range from ES to S
8. ζ : angle to be determined

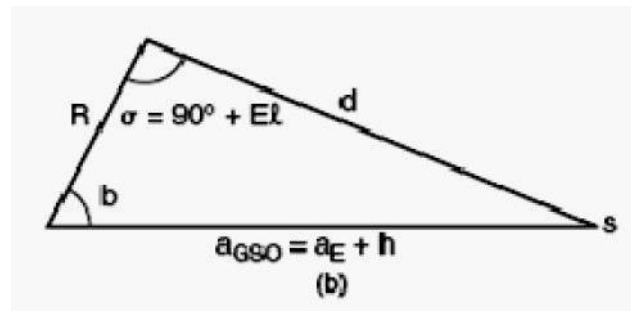

Figure 1.10: A plane triangle obtained from figure 1.8

Considering figure 3.3, it's a spherical triangle. All sides are the arcs of a great circle. Three sides of this triangle are defined by the angles subtended by the centre of the earth.

- o Side a: angle between North Pole and radius of the sub-satellite point.
- o Side b: angle between radius of Earth and radius of the sub-satellite point.
- o Side c: angle between radius of Earth and the North Pole.

$a = 90^0$ and such a spherical triangle is called quadrantal triangle. $c = 90^0 - \lambda$

Angle B is the angle between the plane containing c and the plane containing a.

Thus, $B = \Phi_E - \Phi_{SS}$

Angle A is the angle between the plane containing b and the plane containing c.

Angle C is the angle between the plane containing a and the plane containing b.

$$\text{Thus, } a = 90^\circ$$

$$c = 90^\circ - \lambda E$$

$$B = \Phi E - \Phi SS$$

$$\text{Thus, } b = \arccos(\cos B \cos \lambda E)$$

$$\text{And } A = \arcsin(\sin |B| / \sin b)$$

Applying the cosine rule for plane triangle to the triangle of figure

$$d = \sqrt{R^2 + a_{GSO}^2 - 2Ra_{GSO} \cos b}$$

Applying the sine rule for plane triangles to the triangle of figure 3.3 allows the angle of elevation to be found:

$$El = \arccos\left(\frac{a_{GSO}}{d} \sin b\right)$$

1.9. Limits of visibility

The east and west limits of geostationary are visible from any given Earth station. These limits are set by the geographic coordinates of the Earth station and antenna elevation.

The lowest elevation is zero (in theory) but in practice, to avoid reception of excess noise from Earth. Some finite minimum value of elevation is issued. The earth station can see a satellite over a geostationary arc bounded by $\pm (81.30)$ about the earth station's longitude.

1.10. Eclipse

It occurs when Earth's equatorial plane coincides with the plane of the Earth's orbit around the sun.

Near the time of spring and autumnal equinoxes, when the sun is crossing the equator, the satellite passes into sun's shadow. This happens for some duration of time every day.

These eclipses begin 23 days before the equinox and end 23 days after the equinox. They last for almost 10 minutes at the beginning and end of equinox and increase for a maximum period of 72 minutes at a full eclipse.

The solar cells of the satellite become non-functional during the eclipse period and the satellite is made to operate with the help of power supplied from the batteries.

A satellite will have the eclipse duration symmetric around the time $t = \text{Satellite Longitude}/15 + 12$ hours. A satellite at Greenwich longitude 0 will have the eclipse duration symmetric around 0/15

UTC +12hours = 00:00 UTC.

The eclipse will happen at night but for satellites in the east it will happen late evening local time.

For satellites in the west eclipse will happen in the early morning hour's local time.

An earth caused eclipse will normally not happen during peak viewing hours if the satellite is located near the longitude of the coverage area. Modern satellites are well equipped with batteries for operation during eclipse.

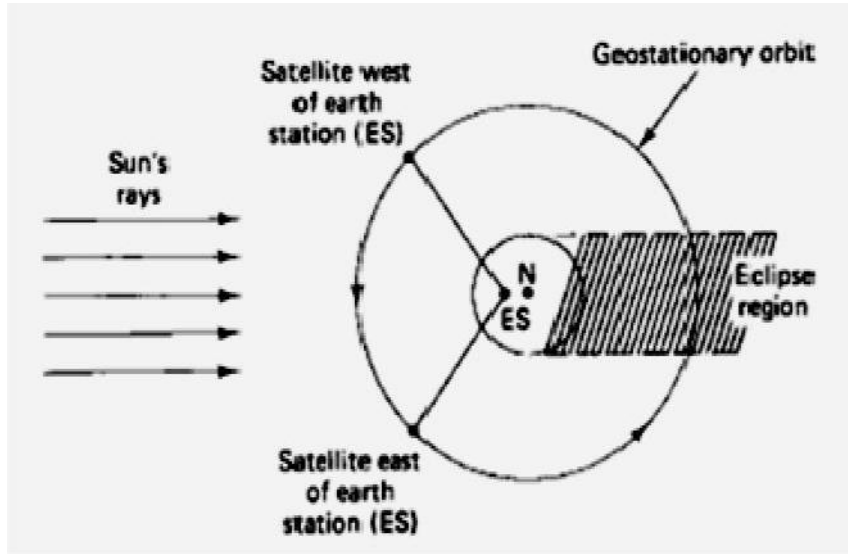

Figure 1.11(i): A satellite east of the earth station enters eclipse during daylight busy hours at the earth station. A Satellite west of earth station enters eclipse during night and early morning hours (non busy time).

1.11. Sub satellite Point

Point at which a line between the satellite and the center of the Earth intersects the Earth's surface

Location of the point expressed in terms of latitude and longitude

If one is in the US it is common to use

- o Latitude – degrees north from equator
- o Longitude – degrees west of the Greenwich meridian

Location of the sub satellite point may be calculated from coordinates of the rotating system as:

$$L_s = \cos^{-1} \frac{z_r}{r}$$

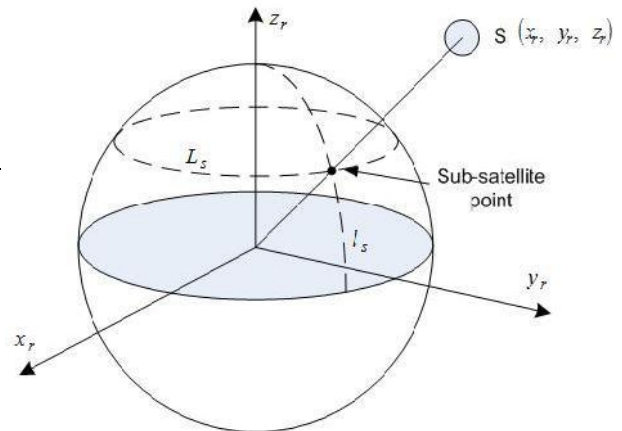

Figure 1.11(ii) Sub satellite Point

1.12. Sun Transit Outage

Sun transit outage is an interruption in or distortion of geostationary satellite signals caused by interference from solar radiation.

Sun appears to be an extremely noisy source which completely blanks out the signal from satellite. This effect lasts for 6 days around the equinoxes. They occur for a maximum period of 10 minutes.

Generally, sun outages occur in February, March, September and October, that is, around the time of the equinoxes.

At these times, the apparent path of the sun across the sky takes it directly behind the line of sight between an earth station and a satellite.

As the sun radiates strongly at the microwave frequencies used to communicate with satellites (C-band, Ka band and Ku band) the sun swamps the signal from the satellite.

The effects of a sun outage can include partial degradation, that is, an increase in the error rate, or total destruction of the signal.

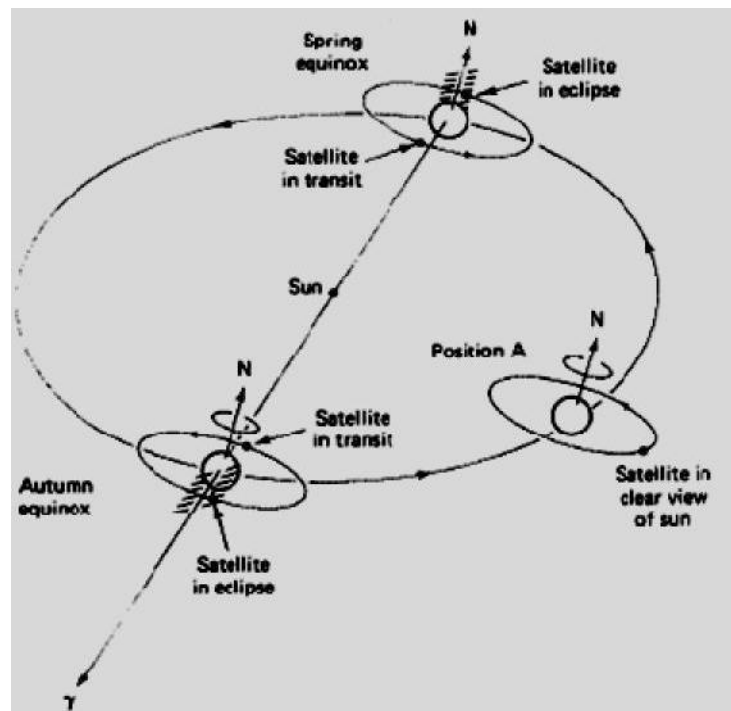

Figure 1.12 : Earth Eclipse of a Satellite and Sun transit Outage

1.13. Launching Procedures

1.13.1 Introduction

Low Earth Orbiting satellites are directly injected into their orbits. This cannot be done in case of GEOs as they have to be positioned 36,000kms above the Earth's surface.

Launch vehicles are hence used to set these satellites in their orbits. These vehicles are reusable. They are also known as „Space Transportation System“(STS).

When the orbital altitude is greater than 1,200 km it becomes expensive to directly inject the satellite in its orbit.

For this purpose, a satellite must be placed in to a transfer orbit between the initial lower orbit and destination orbit. The transfer orbit is commonly known as *Hohmann-Transfer Orbit.

1.13.2 Orbit Transfer

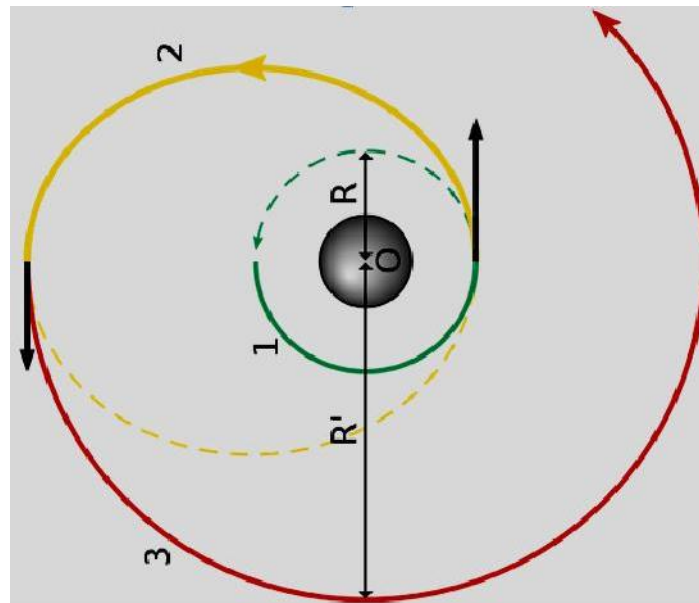

Figure 1.13: Orbit Transfer positions

(*About Hohmann Transfer Orbit: This manoeuvre is named for the German civil engineer who first proposed it, Walter Hohmann, who was born in 1880. He didn't work in rocketry professionally (and wasn't associated with military rocketry), but was a key member of Germany's pioneering Society for Space

Travel that included people such as Willy Ley, Hermann, and Werner von Braun. He published his concept of how to transfer between orbits in his 1925 book, *The Attainability of Celestial Bodies*.)

The transfer orbit is selected to minimize the energy required for the transfer. This orbit forms a tangent to the low attitude orbit at the point of its perigee and tangent to high altitude orbit at the point of its apogee.

1.14 Launch vehicles and propulsion

The rocket injects the satellite with the required thrust** into the transfer orbit. With the STS, the satellite carries a perigee kick motor*** which imparts the required thrust to inject the satellite in its transfer orbit. Similarly, an apogee kick motor (AKM) is used to inject the satellite in its destination orbit.

www.EnggTree.com

Generally it takes 1-2 months for the satellite to become fully functional. The Earth Station performs the Telemetry Tracking and Command**** function to control the satellite transits and functionalities.

(**Thrust: It is a reaction force described quantitatively by Newton's second and third laws. When a system expels or accelerates mass in one direction the accelerated mass will cause a force of equal magnitude but opposite direction on that system.)

Kick Motor refers to a rocket motor that is regularly employed on artificial satellites destined for a geostationary orbit. As the vast majority of geostationary satellite launches are carried out from spaceports at a significant distance away from Earth's equator.

The carrier rocket would only be able to launch the satellite into an elliptical orbit of maximum apogee 35,784-kilometres and with a non-zero inclination approximately equal to the latitude of the launch site.

TT&C: it's a sub-system where the functions performed by the satellite control network to maintain health and status, measure specific mission parameters and processing over time a sequence of these measurement to refine parameter knowledge, and transmit mission commands to the satellite. Detailed study of TT&C in the upcoming units.

1.14.1 Transfer Orbit

It is better to launch rockets closer to the equator because the Earth rotates at a greater speed here than that at either pole. This extra speed at the equator means a rocket needs less thrust (and therefore less fuel) to launch into orbit.

In addition, launching at the equator provides an additional 1,036 mph (1,667 km/h) of speed once the vehicle reaches orbit. This speed bonus means the vehicle needs less fuel, and that freed space can be used to carry more pay load.

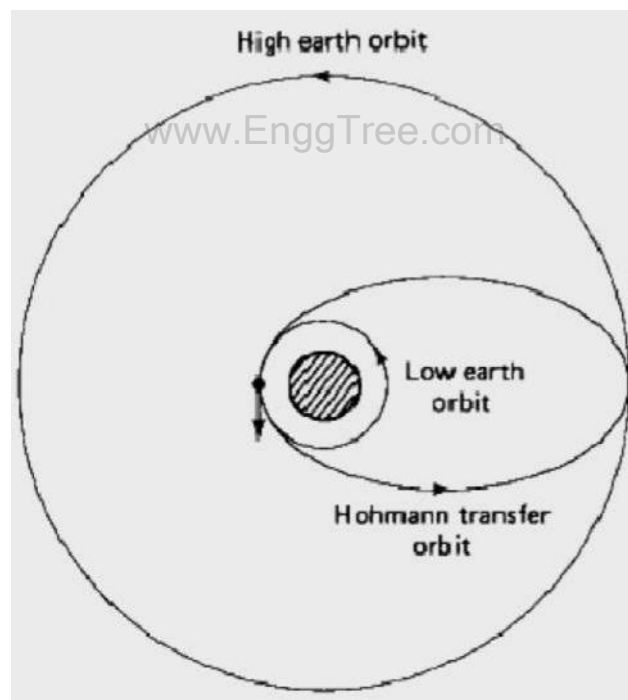

Figure 1.14: Hohmann Transfer Orbit

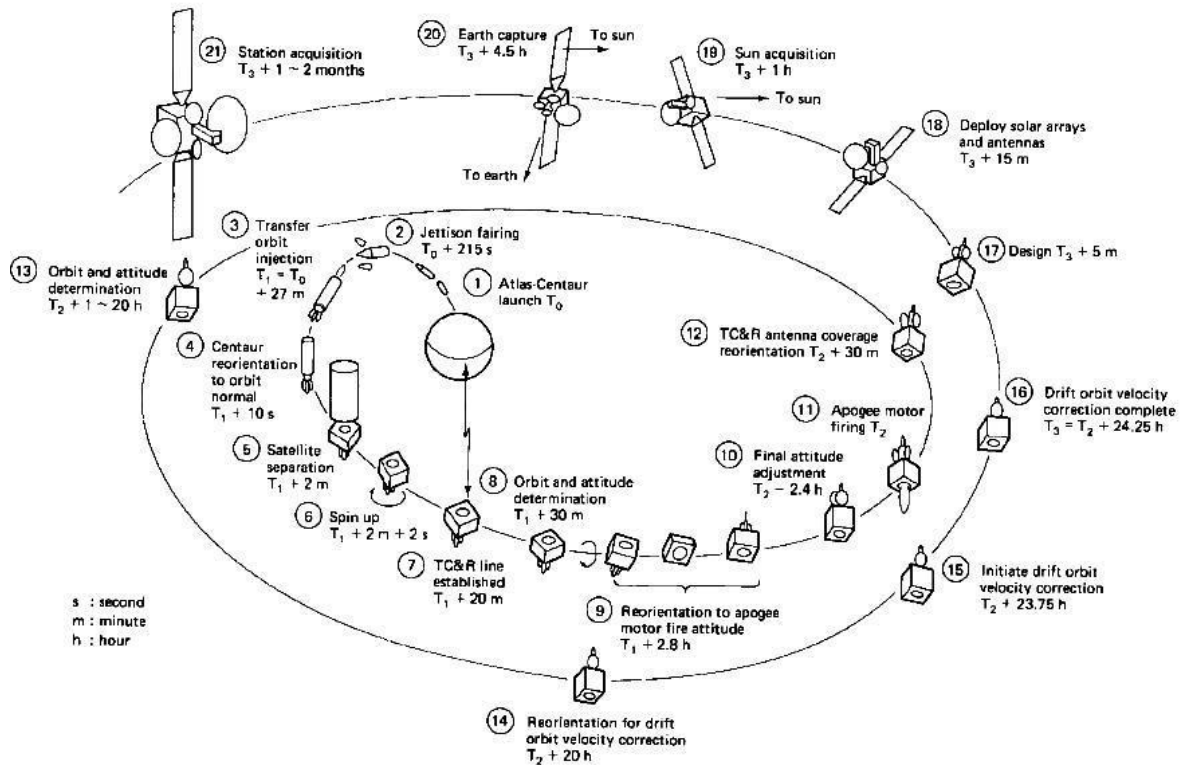

Figure 1.15: Launching stages of a GEO (example INTELSAT)

www.EnggTree.com

Rocket launch

A **rocket launch** is the takeoff phase of the flight of a rocket. Launches for orbital spaceflights, or launches into interplanetary space, are usually from a fixed location on the ground, but may also be from a floating platform (such as the Sea Launch vessel) or, potentially, from a super heavy An-225-class airplane

Launches of suborbital flights (including missile launches), can also be from:

- ❖ a missile silo
- ❖ a mobile launcher vehicle
- ❖ a submarine
- ❖ air launch:
 - from a plane (e.g. Scaled Composites Space Ship One, Pegasus Rocket, X-15)
 - from a balloon (Rockoon, da Vinci Project (under development))
 - a surface ship (Aegis Ballistic Missile Defense System)
 - an inclined rail (e.g. rocket sled launch)

"Rocket launch technologies" generally refers to the entire set of systems needed to successfully launch a vehicle, not just the vehicle itself, but also the firing control systems, ground control station, launch pad, and tracking stations needed for a successful launch and/or recovery.

Orbital launch vehicles commonly take off vertically, and then begin to progressively lean over, usually following a gravity turn trajectory.

Once above the majority of the atmosphere, the vehicle then angles the rocket jet, pointing it largely horizontally but somewhat downwards, which permits the vehicle to gain and then maintain altitude while increasing horizontal speed. As the speed grows, the vehicle will become more and more horizontal until at orbital speed, the engine will cut off.

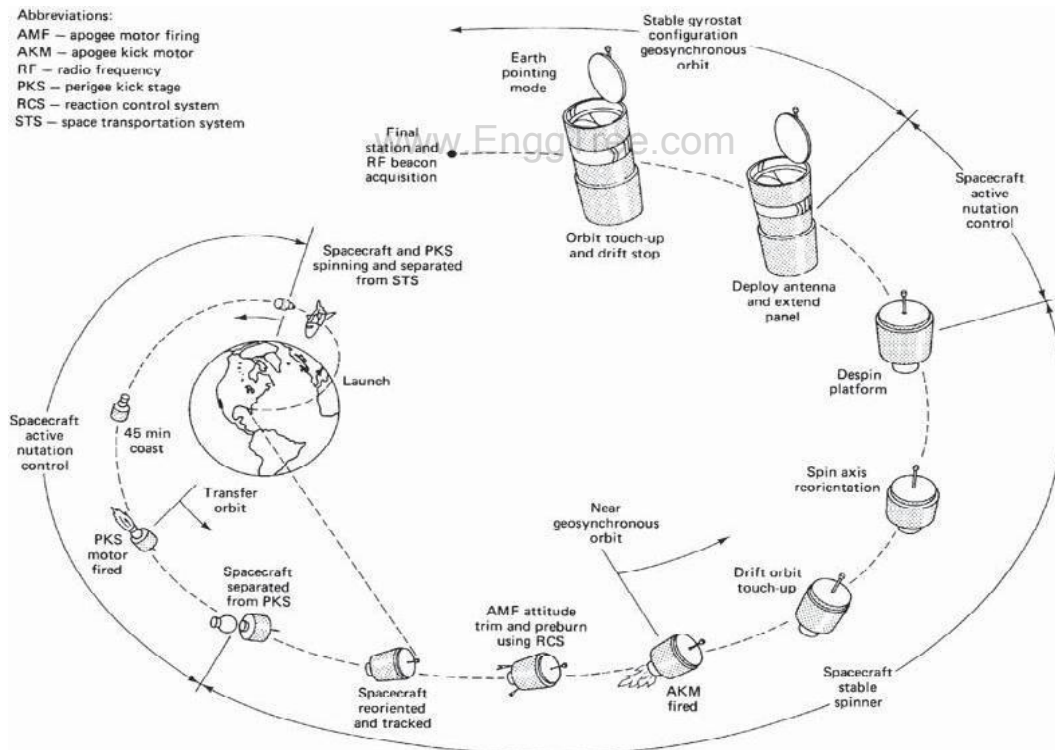

Figure 1.16 STS-7/Anik C2 mission scenario. (From *Anik C2 Launch Handbook*; courtesy of Telesat, Canada.)

APPLICATIONS

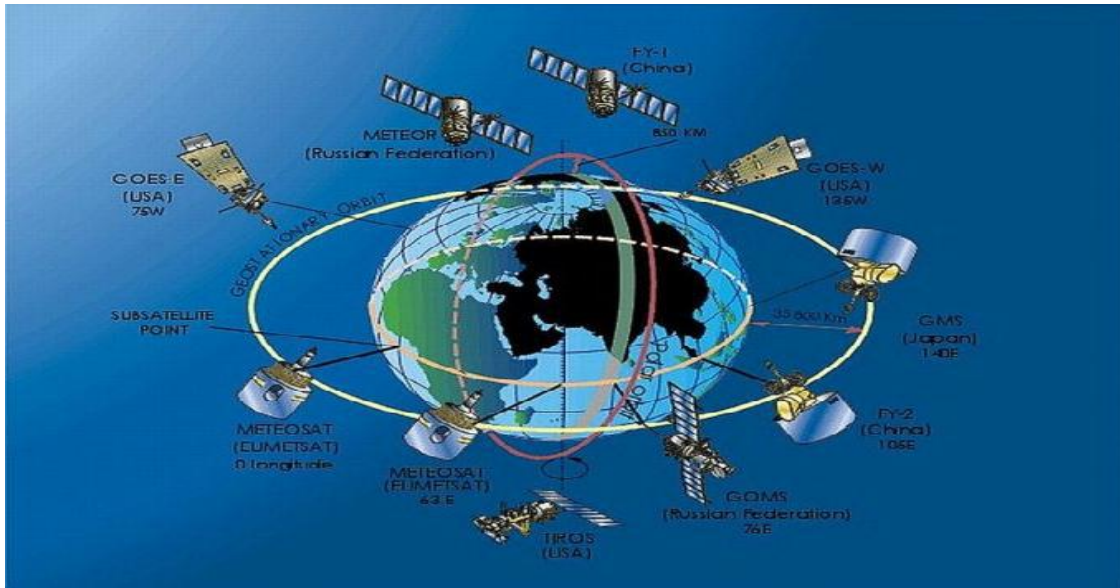

Figure example of geostationary satellites

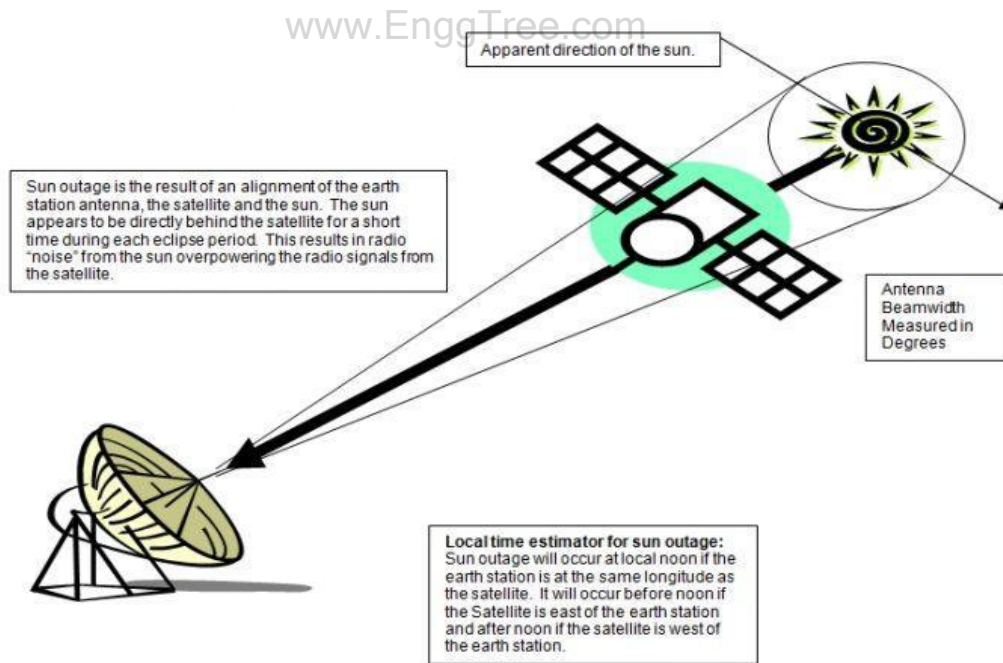

Figure example of sun transit outage

POST TEST MCQ

1. Kepler's first law states

- a) **The path followed by a satellite around the primary will be an ellipse.**
- b) The path followed by a satellite around the primary will be an circle.
- c) The path followed by a satellite around the primary will be an sphere
- d) None of the above

2. INTELSAT stands?

- a) **International Telecommunications Satellite**
- b) India Telecommunications Satellite
- c) Inter Telecommunications Satellite
- d) None of the above

3. The carrier to noise ratio for a satellite depends upon

- (a) Effective Isotropic Radiated power
- (b) Bandwidth.
- (c) Free space path losses
- (d) All of them**

4. Mention the different services of satellite systems.

- a) **Broadcasting satellite services**
- b) Signal transmission
- c) Information transmission
- d) None of the above

5. Calculate the radius of a circular orbit for which the period is 1 day?

- a) **42.241Km**
- b) 42.241m
- c) 4.241Km
- d) 2.241K

6. The period of a satellite, the time required for a satellite to make a complete trip around the Earth, is determined by _____ law.

- a) **Kepler's**
- b) Newton's
- c) Ohm's
- d) none of the above

7. Kepler's second law states

- a) **If $t_2 - t_1 = t_4 - t_3$, then $A_{12} = A_{34}$.**
- b) If $t_2 + t_1 = t_4 + t_3$, then $A_{12} = A_{34}$.
- c) If $t_2/t_1 = t_4/t_3$, then $A_{12} = A_{34}$.
- d) The path followed by a satellite around the primary will be an ellipse

8. Apogee is

- a) **The point farthest from earth**
- b) The point nearest from earth
- c) The point smallest from earth
- d) None of the above

9. Perigee is

- a) The point farthest from earth
- b) The point longest from earth
- c) **The point closest approach to earth**
- d) None of the above

10. True anomaly is

- a) **the angle from perigee to the satellite position, measured at the earth's center.**
- b) The point longest from earth
- c) The point closest approach to earth
- d) None of the above

11. _____ is a loss of power of a satellite downlink signal due to earth's atmosphere.

- a) Atmospheric loss
- b) Path loss**
- c) Radiation loss
- d) RFI

12. Collects very weak signals from a broadcast satellite

- a) Helical antenna
- b) Satellite dish**
- c) LNA
- d) TWT

13. As the height of a satellite orbit gets lower, the speed of the satellite _____.

- a) Increases**
- b) Decreases
- c) Remains the same
- d) None of the above

www.EnggTree.com

14. The term Eclipse is defined as

- a) During equinox periods, the earth the sun & the satellite are in alignment with the result that earth's shadow eclipses that satellite & the sunlight fails to reach the satellite solar cells.**
- b) During equinox periods, the earth the sun & the satellite are in alignment with the result that earth's shadow eclipses that satellite & the sunlight success to reach the satellite solar cells.
- c) a & b
- d) None of above

15. Why are VHF, UHF, and microwave signals used in satellite communication?

- a) More bandwidth
- b) More spectrum space
- c) Are not diffracted by the ionosphere**
- d) Economically viable

16. What is the reason for shifting from c band to ku band in satellite communication?

- a) Lesser attenuation
- b) Less power requirements
- c) More bandwidth
- d) Overcrowding**

17. Which of the following bands cannot be used for satellite communication?

- a) MF**
- b) Ku
- c) X
- d) C

www.EnggTree.com

18. The eclipse effect is noticeable for periods of _____

- (a) about four weeks & the maximum daily eclipse duration is about 1.20 hours.**
- (b) about one weeks & the maximum daily eclipse duration is about 12 hours.
- (c) about five weeks & the maximum daily eclipse duration is about 1.20 hours.**
- (d) about two weeks & the maximum daily eclipse duration is about 1.20 hours.

19. Which technique uses spot beam antennas to divide the area covered by the satellite into smaller segments?

- a) Spatial isolation**
- b) Frequency reuse
- c) Multiplexing
- d) Modulation

CONCLUSION

- ❖ In this unit, analysis of the satellite orbits, geo stationary and non Geo-stationary orbits was discussed.
- ❖ The Kepler's Laws, Newton's law were elaborated.
- ❖ The Sub satellite point –Sun transit outage-Launching Procedures - launch vehicles and propulsion was discussed.

REFERENCES

1. Wilbur L.Pritchard, Hendri G. Suyderhoud, Robert A. Nelson, "Satellite Communication Systems Engineering", Prentice Hall/Pearson, 2007.
2. N. Agarwal, "Design of Geosynchronous Space Craft", Prentice Hall, 1986.
3. Bruce R. Elbert, "Satellite Communication Applications", Hand Book, Artech House Bostan London,1997.
4. Tri T. Ha, "Digital Satellite Communication", II nd edition, 1990.
5. Robert G. Winch, "Telecommunication Transmission Systems", Mc Graw-Hill Book Co., 1983.
6. Brian Ackroyd, "World Satellite Communication and earth station Design", BSP professional Books, 1990.
7. G.B.Bleazard, "Introducing Satellite communications", NCC Publication, 1985.
8. M.Richharia, "Satellite Communication Systems-Design Principles", Macmillan 2003.
9. Emanuel Fthenakis, "Manual of Satellite Communications", Mc Graw Hill Book Co., 1984

ASSIGNMENT

1. Explain the Kepler's law of planetary motion and how are they applicable to the geostationary satellite.
2. What is orbit ? Derive an expression for the equation of satellite orbit.
3. What is meant by look angles ? Explain them with reference to a geostationary satellite and earth station.
4. Explain briefly the orbital parameters required to determine a satellite's orbit.
5. Explain the concept of earth coverage and slant range for geostationary satellite? What are the maximum values of these parameter.
6. Explain the concept and significance of station keeping. What are N-S and E-W station keeping.
7. Explain how a satellite is placed into geostationary orbit from earth ?
8. What is meant by /orbit perturbations? Explain in brief.
9. Differentiate between geosynchronous and geostationary orbit.
10. Briefly discuss the various types of orbits.

SATELLITE COMMUNICATION

www.EnggTree.com

UNIT II SPACE SEGMENT AND SATELLITE LINK DESIGN

UNIT II SPACE SEGMENT AND SATELLITE LINK DESIGN

AIM & OBJECTIVE

- ❖ To understand the satellite segment and earth segment.
- ❖ To analyze the Satellite Uplink and Downlink.
- ❖ To understand the G/T ratio-Performance Impairments-System noise.

PRE -TEST MCQ

1. For satellite communication, standard Earth stations have antenna diameters in the range of _____ metre.

- a) **27.5 to 30**
- b) 10 to 15
- c) 30 to 50
- d) 5 to 10

www.EnggTree.com

2. In satellite communication, frequency modulation is used because satellite channel has

- a) small bandwidth and negligible noise
- b) **large bandwidth and severe noise**
- c) maximum bandwidth and minimum noise
- d) high modulation index

3. The noise temperature of sky is about _____ °K.

- a) 100
- b) 273
- c) 0
- d) **30**

2.1 Spacecraft Technology- Structure

A satellite communications system can be broadly divided into two segments—a ground segment and a space segment.

The space segment will obviously include the satellites, but it also includes the ground facilities needed to keep the satellites operational, these being referred to as the *tracking, telemetry, and command* (TT&C) facilities. In many networks it is common practice to employ a ground station solely for the purpose of TT&C.

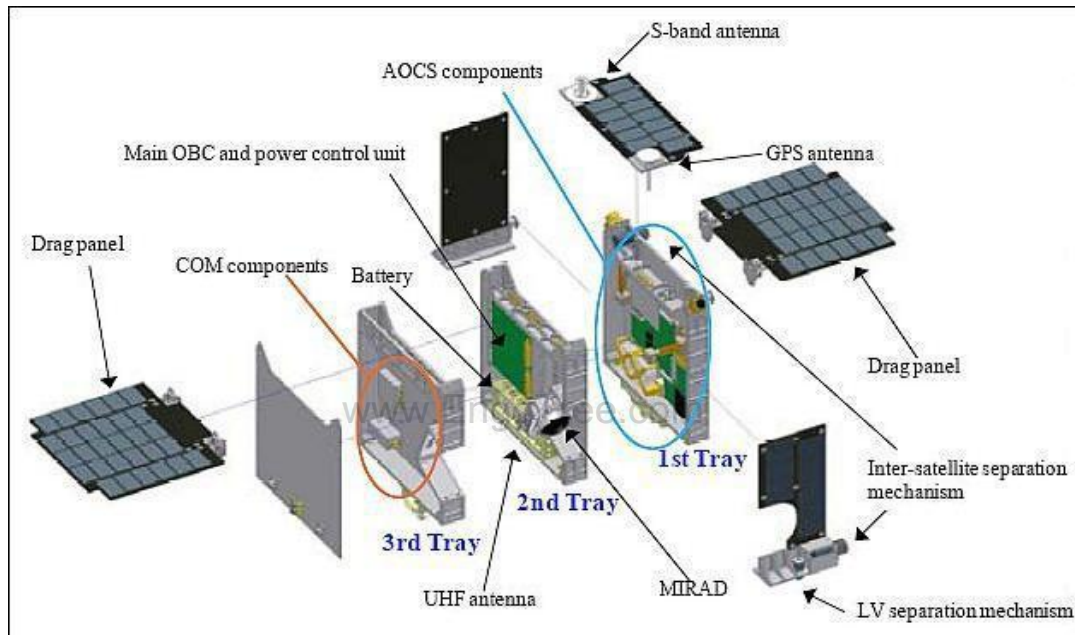

Figure 2.1 (a) Satellite Structure

The equipment carried aboard the satellite also can be classified according to function. The *payload* refers to the equipment used to provide the service for which the satellite has been launched.

In a communications satellite, the equipment which provides the connecting link between the satellite's transmit and receive antennas is referred to as the *transponder*. The transponder forms one of the main sections of the payload, the other being the antenna subsystems. In this chapter the main characteristics of certain bus systems and payloads are described.

2.2 The Power Supply

The primary electrical power for operating the electronic equipment is obtained from solar cells. Individual cells can generate only small amounts of power, and therefore, arrays of cells in series-parallel connection are required.

Figure shows the solar cell panels for the HS 376 satellite manufactured by Hughes Space and Communications Company.

In geostationary orbit the telescoped panel is fully extended so that both are exposed to sun- light. At the beginning of life, the panels produce 940 W dc power, which may drop to 760 W at the end of 10 years.

During eclipse, power is provided by two nickel-cadmium (Ni-Cd) long-life batteries, which will deliver 830 W. At the end of life, battery recharge time is less than 16 h.

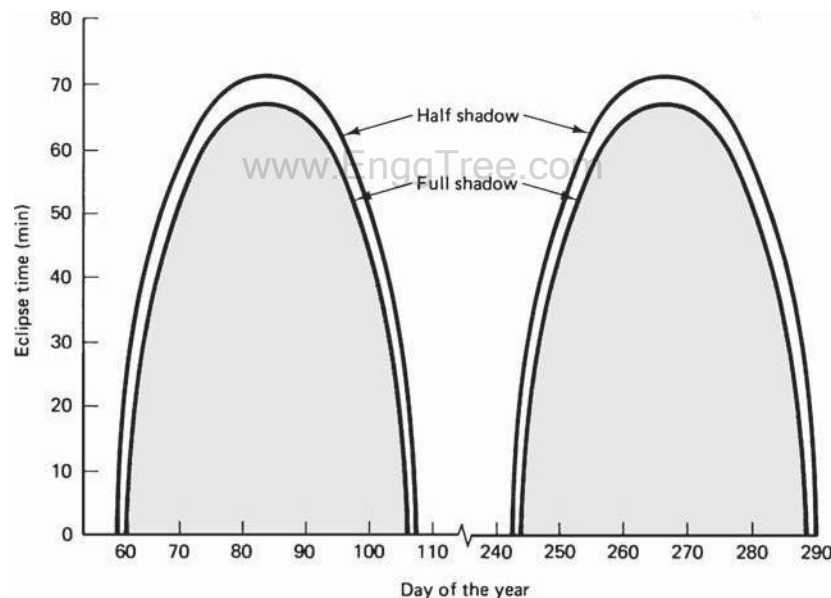

Figure 2.1.(b) Satellite eclipse time as a function of the current day of the year. (Courtesy of Spilker, 1977. Reprinted by permission of Prentice-Hall, Englewood Cliffs, NJ.)

capacity of cylindrical and solar-sail satellites, the cross-over point is estimated to be about 2 kW, where the solar-sail type is more economical than the cylindrical type (Hyndman, 1991).

2.3 Attitude Control & Orbit Control

The *attitude* of a satellite refers to its orientation in space. Much of the equipment carried aboard a satellite is there for the purpose of controlling its attitude. Attitude control is necessary, for example, to ensure that directional antennas point in the proper directions.

In the case of earth environmental satellites, the earth-sensing instruments must cover the required regions of the earth, which also requires attitude control. A number of forces, referred to as *disturbance torques*, can alter the attitude, some examples being the gravitational fields of the earth and the moon, solar radiation, and meteorite impacts.

Attitude control must not be confused with station keeping, which is the term used for maintaining a satellite in its correct orbital position, although the two are closely related.

To exercise attitude control, there must be available some measure of a satellite's orientation in space and of any tendency for this to shift. In one method, infrared sensors, referred to as *horizon detectors*, are used to detect the rim of the earth against the background of space.

With the use of four such sensors, one for each quadrant, the center of the earth can be readily established as a reference point.

Usually, the attitude-control process takes place aboard the satellite, but it is also possible for control signals to be transmitted from earth, based on attitude data obtained from the satellite.

Also, where a shift in attitude is desired, an *attitude maneuver* is executed. The control signals needed to achieve this maneuver may be transmitted from an earth station.

Controlling torques may be generated in a number of ways. *Passive attitude control* refers to the use of mechanisms which stabilize the satellite without putting a drain on the satellite's energy supplies; at most, infrequent use is made of these supplies, for example, when thruster jets are impulsed to provide corrective torque. Examples of passive attitude control are *spin stabilization* and *gravity gradient stabilization*.

The other form of attitude control is *active control*. With active attitude control, there is no overall stabilizing torque present to resist the disturbance torques. Instead, corrective torques are applied as required in response to disturbance torques. Methods used to generate active control torques include momentum wheels, electromagnetic coils, and mass expulsion devices, such as gas jets and ion thrusters.

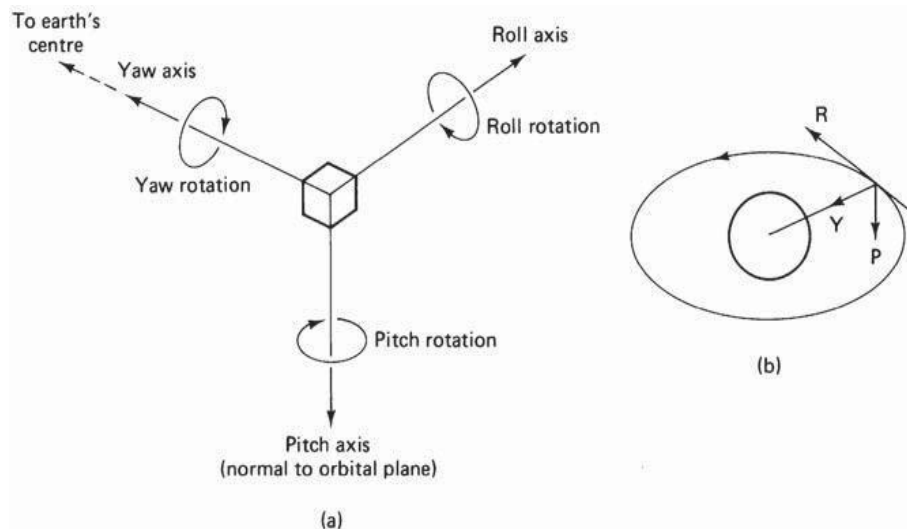

Figure 2.2 (a) Roll, pitch, and yaw axes. The yaw axis is directed toward the earth's center, the pitch axis is normal to the orbital plane, and the roll axis is perpendicular to the other two. (b) RPY axes for the geostationary orbit. Here, the roll axis is tangential to the orbit and lies along the satellite velocity vector.

The three axes which define a satellite's attitude are its *roll*, *pitch*, and *yaw* (RPY) axes. These are shown relative to the earth in Fig. 7.4. All three axes pass through the center of gravity of the satellite. For an equatorial orbit, movement of the satellite about the roll axis moves the antenna footprint north and south; movement about the pitch axis moves the footprint east and west; and movement about the yaw axis rotates the antenna footprint.

2.3.1 Spinning satellite stabilization

Spin stabilization may be achieved with cylindrical satellites. The satellite is constructed so that it is mechanically balanced about one particular axis and is then set spinning around this axis. For geostationary satellites, the spin axis is adjusted to be parallel to the N-S axis of the earth, as illustrated in Fig. 7.5. Spin rate is typically in the range of 50 to 100 rev/min. Spin is initiated during the launch phase by means of small gas jets.

In the absence of disturbance torques, the spinning satellite would maintain its correct attitude relative to the earth. Disturbance torques are generated in a number of ways, both external and internal to the satellite.

Solar radiation, gravitational gradients, and meteorite impacts are all examples of external forces which can give rise to disturbance torques. Motor-bearing friction and the movement of satellite elements such as the antennas also can give rise to disturbance torques. The

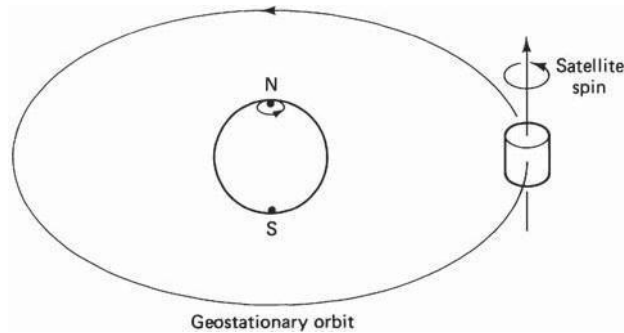

Figure 2.3 Spin stabilization in the geostationary orbit. The spin axis lies along the pitch axis, parallel to the earth's N-S axis.

overall effect is that the spin rate will decrease, and the direction of the angular spin axis will change. Impulse-type thrusters, or jets, can be used to increase the spin rate again and to shift the axis back to its correct N-S orientation.

Nutation, which is a form of wobbling, can occur as a result of the disturbance torques and/or from misalignment or unbalance of the control jets. This nutation must be damped out by means of energy absorbers known as *nutation dampers*.

The antenna feeds can therefore be connected directly to the transponders without the need for radiofrequency (rf) rotary joints, while the complete platform is despun. Of course, control signals and power must be transferred to the despun section, and a mechanical bearing must be provided.

The complete assembly for this is known as the *bearing and power transfer assembly* (BAPTA). Figure 2.4 shows a photograph of the internal structure of the HS 376.

Certain dual-spin spacecraft obtain spin stabilization from a spinning flywheel rather than by spinning the satellite itself. These flywheels are termed *momentum wheels*, and their average momentum is referred to as *momentum bias*

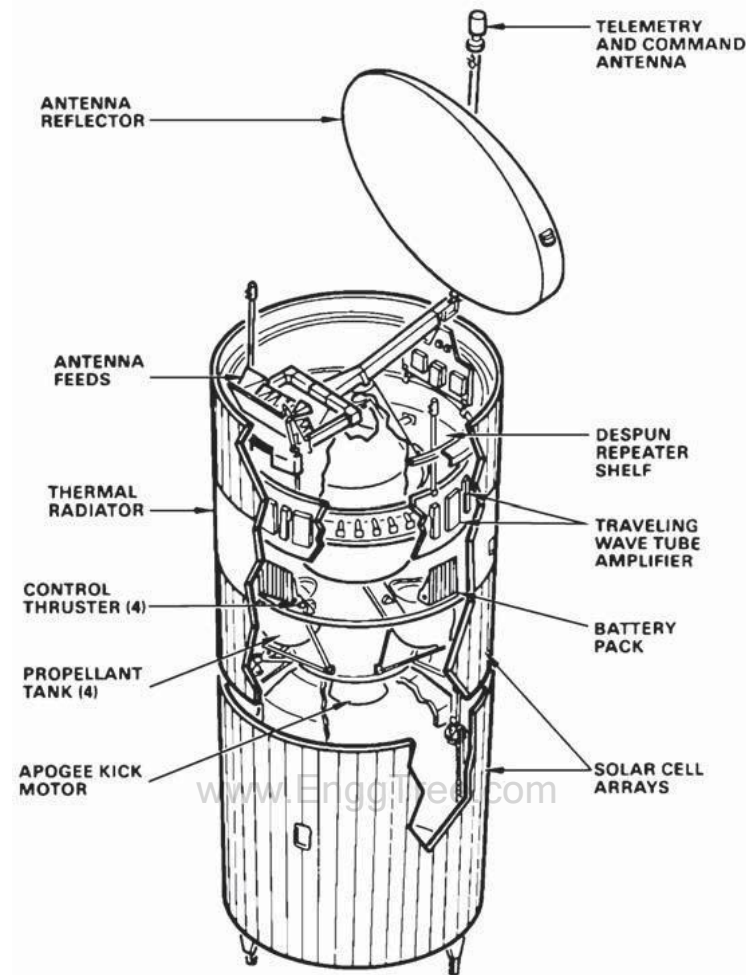

Figure 2.4 HS 376 spacecraft. (Courtesy of Hughes Aircraft Company Space and Communication Group.)

2.3.2 Momentum wheel stabilization

In the previous section the gyroscopic effect of a spinning satellite was shown to provide stability for the satellite attitude.

Stability also can be achieved by utilizing the gyroscopic effect of a spinning flywheel, and this approach is used in satellites with cube-like bodies (such as shown in Fig. and the INTELSAT V type satellites shown in Fig. These are known as *body-stabilized* satellites.

The complete unit, termed a momentum wheel, consists of a flywheel, the bearing assembly, the casing, and an electric drive motor with associated electronic control circuitry.

The flywheel is attached to the rotor, which consists of a permanent magnet providing the magnetic field for motor action. The stator of the motor is attached to the body of the satellite.

Thus the motor provides the coupling between the flywheel and the satellite structure. Speed and torque control of the motor is exercised through the currents fed to the stator.

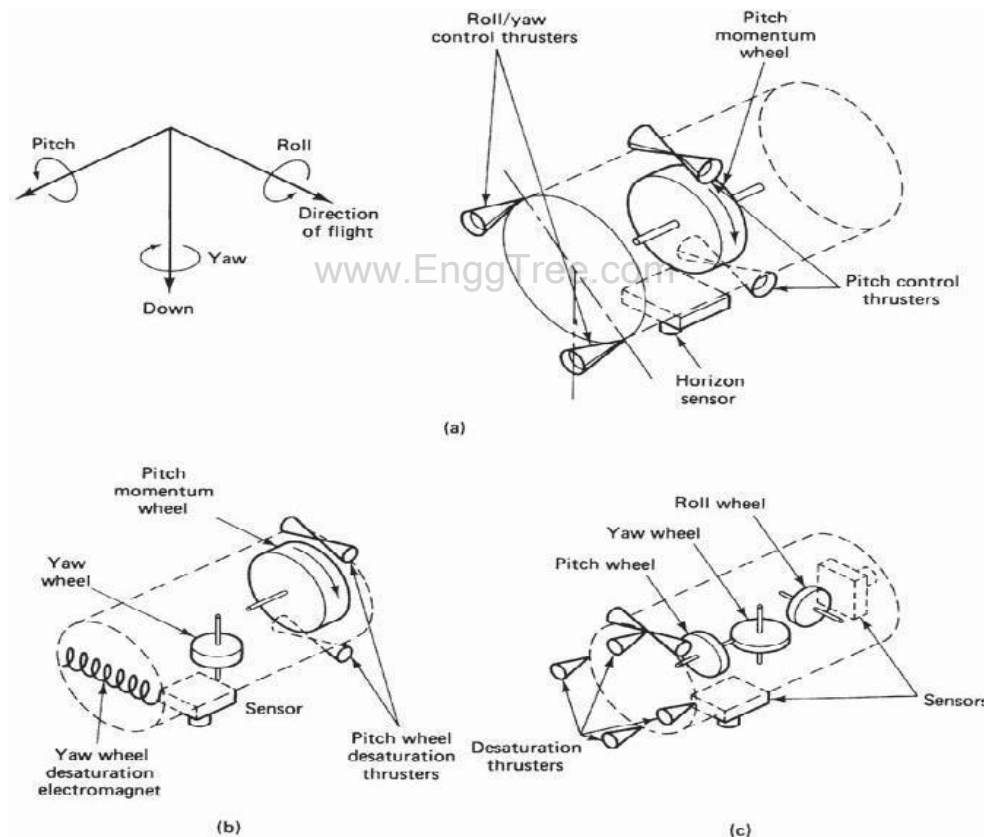

Figure 2.5 Alternative momentum wheel stabilization systems: (a) one-wheel, (b) two-wheel, (c) three-wheel.

When a momentum wheel is operated with zero momentum bias, it is generally referred to as a *reaction wheel*. Reaction wheels are used in three-axis stabilized systems. Here, as the name suggests, each axis is stabilized by a reaction wheel, as shown in Fig. 7.8c. Reaction wheels can also be combined with a momentum wheel to provide the control needed (Chetty, 1991).

Random and cyclic disturbance torques tends to produce zero momentum on average. However, there will always be some disturbance torques that causes a cumulative increase in wheel momentum, and eventually at some point the wheel *saturates*.

In effect, it reaches its maximum allowable angular velocity and can no longer take in any more momentum. Mass expulsion devices are then used to unload the wheel, that is, remove momentum from it (in the same way a brake removes energy from a moving vehicle). Of course, operation of the mass expulsion devices consumes part of the satellite's fuel supply.

2.4 Thermal Control and Propulsion

Satellites are subject to large thermal gradients, receiving the sun's radiation on one side while the other side faces into space. In addition, thermal radiation from the earth and the earth's *albedo*, which is the fraction of the radiation falling on earth which is reflected, can be significant for low-altitude earth-orbiting satellites, although it is negligible for geostationary satellites.

Equipment in the satellite also generates heat which has to be removed. The most important consideration is that the satellite's equipment should operate as nearly as possible in a stable temperature environment. Various steps are taken to achieve this. Thermal blankets and shields may be used to provide insulation. Radiation mirrors are often used to remove heat from the communications payload.

The mirrored thermal radiator for the Hughes HS 376 satellite can be seen in Fig. These mirrored drums surround the communications equipment shelves in each case and provide good radiation paths for the generated heat to escape into the surrounding space.

One advantage of spinning satellites compared with body-stabilized is that the spinning body provides an averaging of the temperature extremes experienced from solar flux and the cold background of deep space.

In order to maintain constant temperature conditions, heaters may be switched on (usually on command from ground) to make up for the heat reduction which occurs when transponders are switched off. The INTELSAT VI satellite used heaters to maintain propulsion thrusters and line temperatures (Pilcher, 1982).

2.5 Communication Payload & Supporting Subsystems

The physical principle of establishing communication connections between remote communication devices dates back to the late 1800s when scientists were beginning to understand electromagnetism and discovered that electromagnetic (EM) radiation (also called EM waves) generated by one device can be detected by another located at some distance away.

By controlling certain aspects of the radiation (through a process called modulation , explained in Section 4.4), useful information can be embedded in the EM waves and transmitted from one device to another.

The second major module is the communication payload, which is made up of transponders. A transponder is capable of :

- Receiving uplinked radio signals from earth satellite transmission stations (antennas).

- Amplifying received radio signals

- Sorting the input signals and directing the output signals through input/output signal multiplexers to the proper downlink antennas for retransmission to earth satellite receiving stations (antennas).

2.6 TT&C Subsystem

The TT&C subsystem performs several routine functions aboard the spacecraft. The telemetry, or telemetering, function could be interpreted as *measurement at a distance*. Specifically, it refers to the overall operation of generating an electrical signal proportional to the quantity being measured and encoding and transmitting this to a distant station, which for the satellite is one of the earth stations.

Data which are transmitted as telemetry signals include attitude information such as that obtained from sun and earth sensors; environmental information such as the magnetic field intensity and direction, the frequency of meteorite impact, and so on; and spacecraft information such as temperatures, power supply voltages, and stored-fuel pressure.

Telemetry and command may be thought of as complementary functions. The telemetry subsystem transmits information about the satellite to the earth station, while the command subsystem receives command signals from the earth station, often in response to telemetered information. The command subsystem

demodulates and, if necessary, decodes the command signals and routes these to the appropriate equipment needed to execute the necessary action.

Thus attitude changes may be made, communication transponders switched in and out of circuits, antennas redirected, and station-keeping maneuvers carried out on command. It is clearly important to prevent unauthorized commands from being received and decoded, and for this reason, the command signals are often encrypted.

Encrypt is derived from a Greek word *kryptein*, meaning *to hide*, and represents the process of concealing the command signals in a secure code. This differs from the normal process of encoding which converts characters in the command signal into a code suitable for transmission.

Tracking of the satellite is accomplished by having the satellite transmit beacon signals which are received at the TT&C earth stations.

Tracking is obviously important during the transfer and drift orbital phases of the satellite launch. Once it is on station, the position of a geostationary satellite will tend to be shifted as a result of the various disturbing forces, as described previously.

Therefore, it is necessary to be able to track the satellite's movement and send correction signals as required.

2.6.1 Transponders

A transponder is the series of interconnected units which forms a single communications channel between the receive and transmit antennas in a communications satellite.

Some of the units utilized by a transponder in a given channel may be common to a number of transponders. Thus, although reference may be made to a specific transponder, this must be thought of as an equipment *channel* rather than a single item of equipment.

Before describing in detail the various units of a transponder, the overall frequency arrangement of a typical C-band communications satellite will be examined briefly. The bandwidth allocated for C-band service is 500 MHz, and this is divided into subbands, one transponder.

A typical transponder bandwidth is 36 MHz, and allowing for a 4-MHz guardband between transponders, 12 such transponders can be accommodated in the 500-MHz bandwidth.

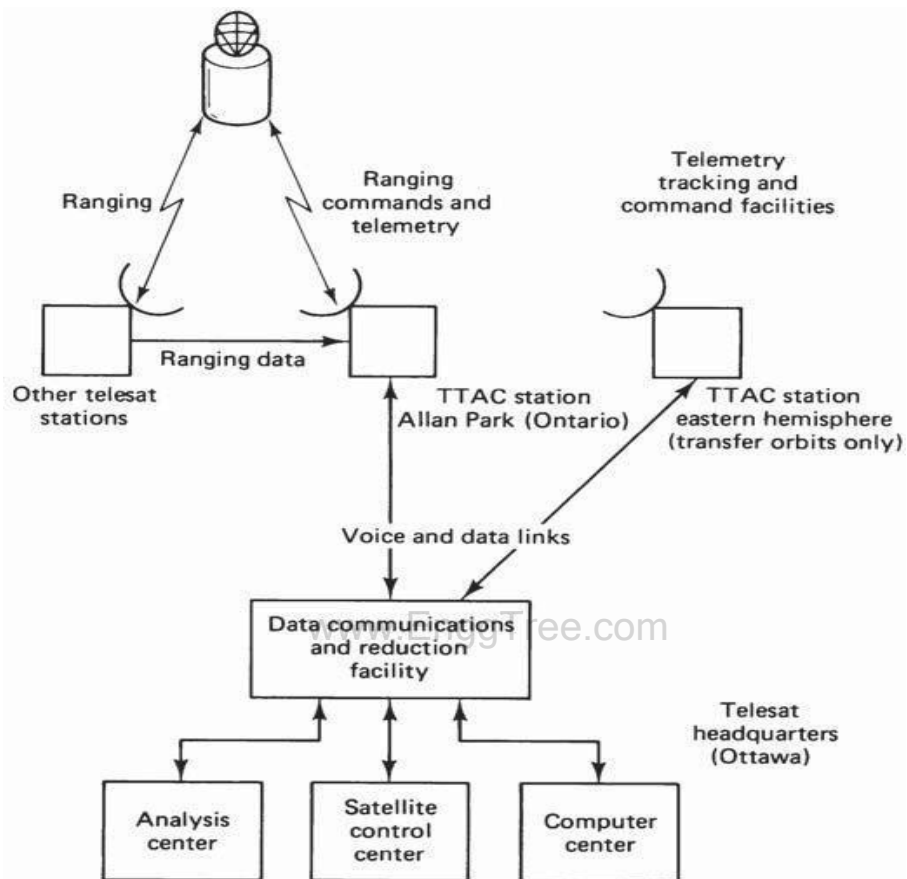

Figure 2.8 Satellite control system. (Courtesy of Telesat Canada, 1983.)

By making use of *polarization isolation*, this number can be doubled. Polarization isolation refers to the fact that carriers, which may be on the same frequency but with opposite senses of polarization, can be isolated from one another by receiving antennas matched to the incoming polarization.

With linear polarization, vertically and horizontally polarized carriers can be separated in this way, and with circular polarization, left-hand circular and right-hand circular polarizations can be separated.

Because the carriers with opposite senses of polarization may overlap in frequency, this technique is referred to as *frequency reuse*. Figure 2.9 shows part of the frequency and polarization plan for a C-band communications satellite.

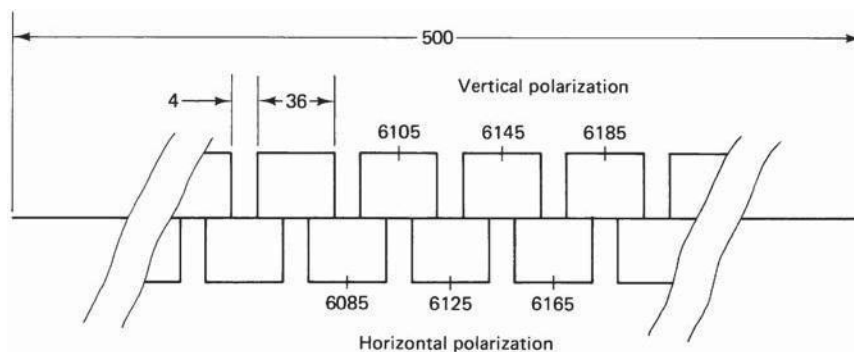
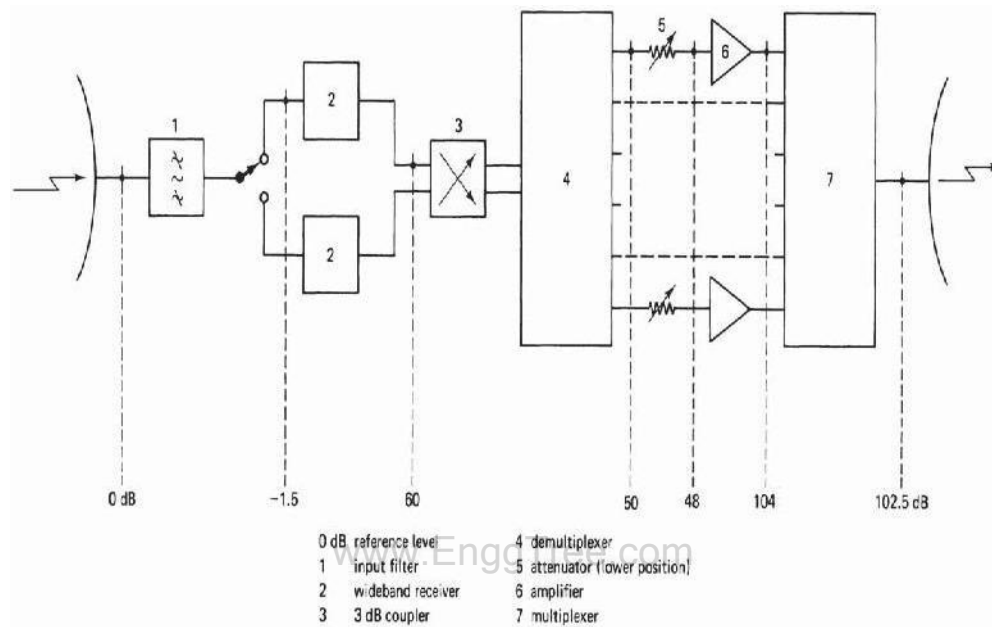

Figure 2.9 Section of an uplink frequency and polarization plan. Numbers refer to frequency in megahertz.

Frequency reuse also may be achieved with spot-beam antennas, and these may be combined with polarization reuse to provide an effective bandwidth of 2000 MHz from the actual bandwidth of 500 MHz.

For one of the polarization groups, Fig. 2.9 shows the channeling scheme for the 12 transponders in more detail. The incoming, or uplink, frequency range is 5.925 to 6.425 GHz.

The frequency conversion shifts the carriers to the downlink frequency band, which is also 500 MHz wide, extending from 3.7 to 4.2 GHz. At this point the signals are channelized into frequency bands which represent the individual transponder bandwidths.

2.6.2 The wideband receiver

The wideband receiver is shown in more detail in Fig. 2.10. A duplicate receiver is provided so that if one fails, the other is automatically switched in. The combination is referred to as a *redundant receiver*, meaning that although two are provided, only one is in use at a given time.

The first stage in the receiver is a *low-noise amplifier* (LNA). This amplifier adds little noise to the carrier being amplified, and at the same time it provides sufficient amplification for the carrier to override the higher noise level present in the following mixer stage.

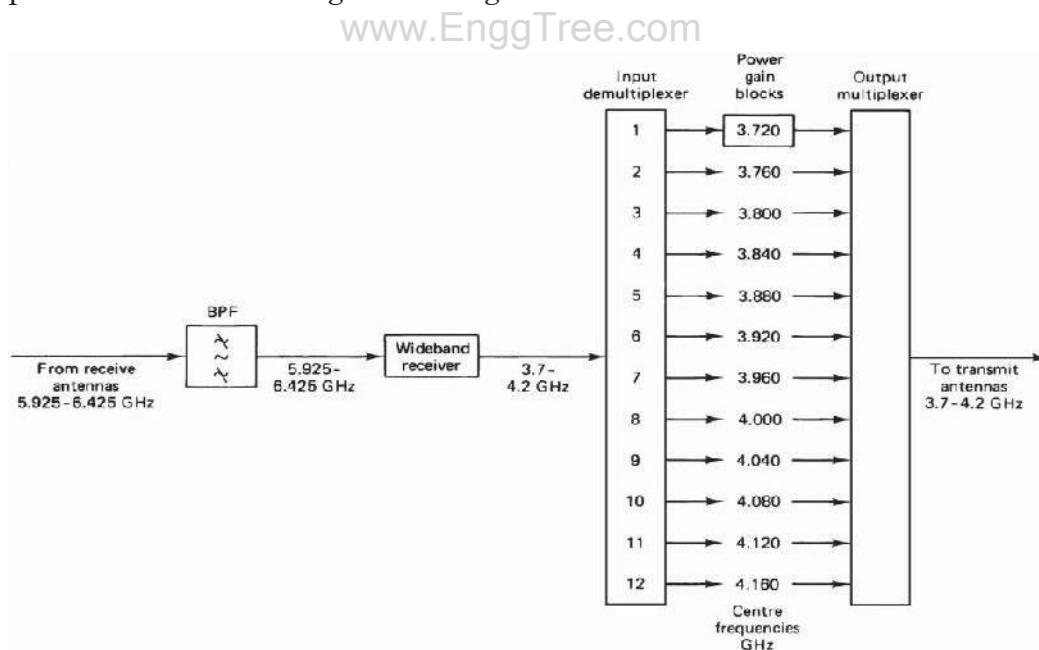

Figure 2.10 Satellite transponder channels

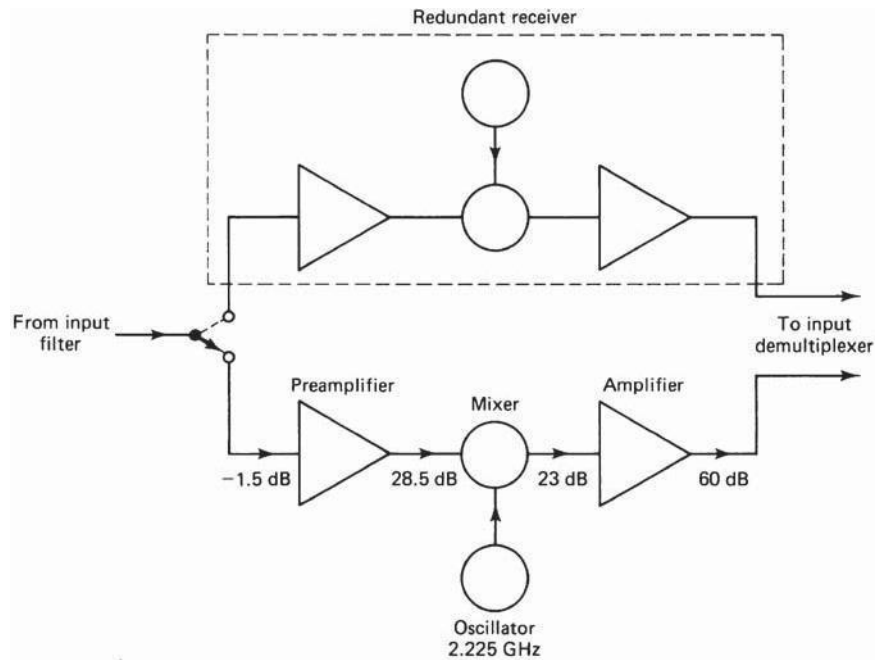

Figure 2.11 Satellite wideband receiver. (Courtesy of CCIR, *CCIR Fixed Satellite Services Handbook, final draft 1984.*)

involving noise, it is usually more convenient to refer all noise levels to the LNA input, where the total receiver noise may be expressed in terms of an equivalent noise temperature.

In a well-designed receiver, the equivalent noise temperature referred to the LNA input is basically that of the LNA alone. The overall noise temperature must take into account the noise added from the antenna, and these calculations are presented in detail in Chap. 12. The equivalent noise temperature of a satellite receiver may be on the order of a few hundred kelvins.

The LNA feeds into a mixer stage, which also requires a *local oscillator* (LO) signal for the frequency-conversion process.

With advances in *field-effect transistor* (FET) technology, FET amplifiers, which offer equal or better performance, are now available for both bands. Diode mixer stages are used.

The amplifier following the mixer may utilize *bipolar junction transistors* (BJTs) at 4 GHz and FETs at 12 GHz, or FETs may in fact be used in both bands.

2.6.3 The input demultiplexer

The input demultiplexer separates the broadband input, covering the frequency range 3.7 to 4.2 GHz, into the transponder frequency channels.

This provides greater frequency separation between adjacent channels in a group, which reduces adjacent channel interference.

The output from the receiver is fed to a power splitter, which in turn feeds the two separate chains of circulators.

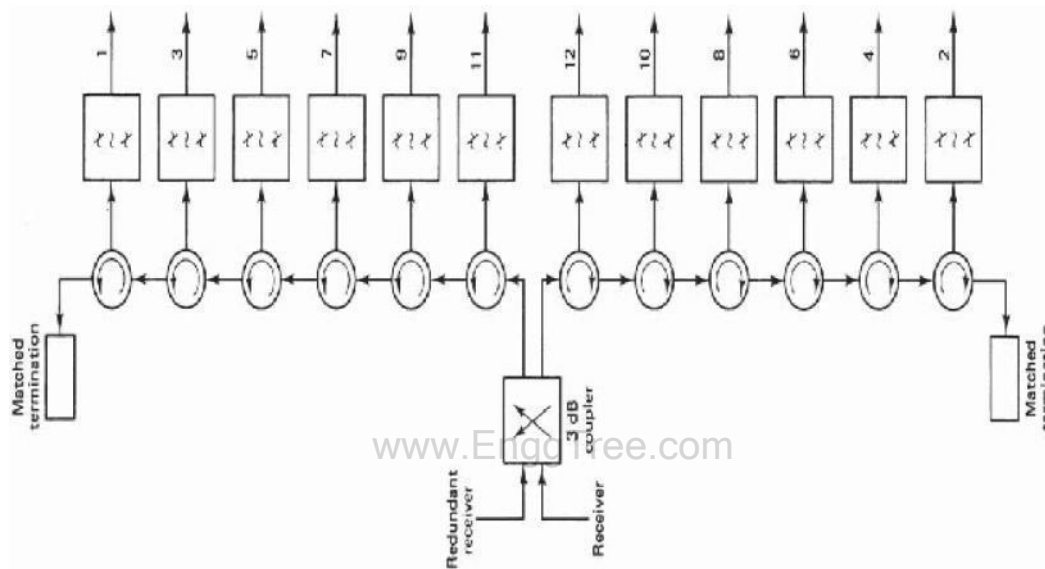

Figure 2.12 Satellite input multiplexer

The full broadband signal is transmitted along each chain, and the channelizing is achieved by means of channel filters connected to each circulator,

Each filter has a bandwidth of 36 MHz and is tuned to the appropriate center frequency, as shown in Fig. 2.11.

Although there are considerable losses in the demultiplexer, these are easily made up in the overall gain for the transponder channels.

2.6.4 The power amplifier

The fixed attenuation is needed to balance out variations in the input attenuation so that each transponder channel has the same nominal attenuation, the necessary adjustments being made during assembly.

The variable attenuation is needed to set the level as required for different types of service (an example being the requirement for input power backoff discussed later). Because this variable attenuator adjustment is an operational requirement, it must be under the control of the ground TT&C station.

Traveling-wave tube amplifiers (TWTAs) are widely used in transponders to provide the final output power required to the transmit antenna. Figure 2.13 shows the schematic of a *traveling wave tube (TWT)* and its power supplies.

In the TWT, an electron-beam gun assembly consisting of a heater, a cathode, and focusing electrodes is used to form an electron beam. A magnetic field is required to confine the beam to travel along the inside of a wire helix.

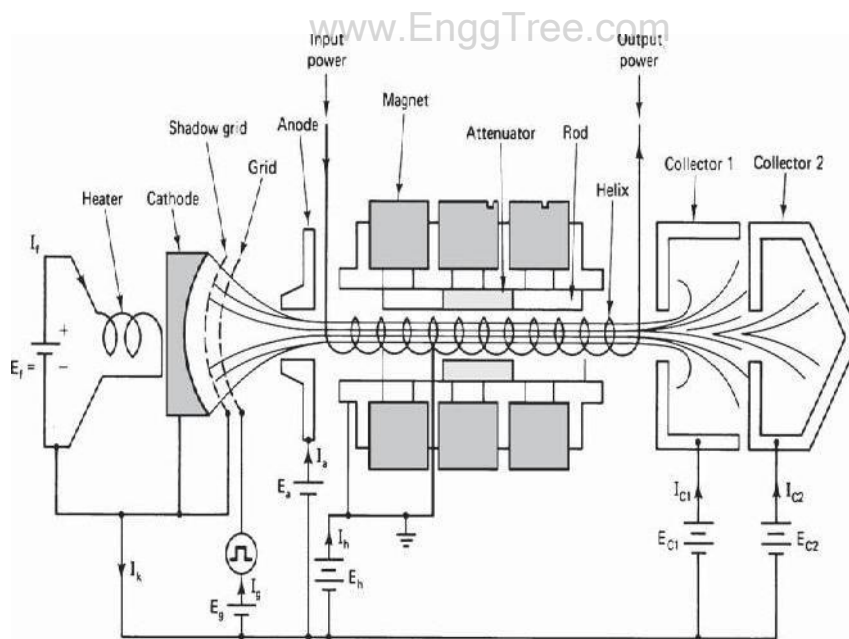

Figure 2.13 Satellite TWT

used in ground stations, the magnetic field can be provided by means of a solenoid and dc power supply. The comparatively large size and high power consumption of solenoids make them unsuitable for use aboard satellites, and lower-power TWTs are used which employ permanent-magnet focusing.

The wave actually will travel around the helical path at close to the speed of light, but it is the axial component of wave velocity which interacts with the electron beam.

This component is less than the velocity of light approximately in the ratio of helix pitch to circumference. Because of this effective reduction in phase velocity, the helix is referred to as a *slowwave structure*.

The advantage of the TWT over other types of tube amplifiers is that it can provide amplification over a very wide bandwidth. Input levels to the TWT must be carefully controlled, however, to minimize the effects of certain forms of distortion.

The worst of these result from the nonlinear transfer characteristic of the TWT, illustrated in Fig. 2.14.

www.EnggTree.com

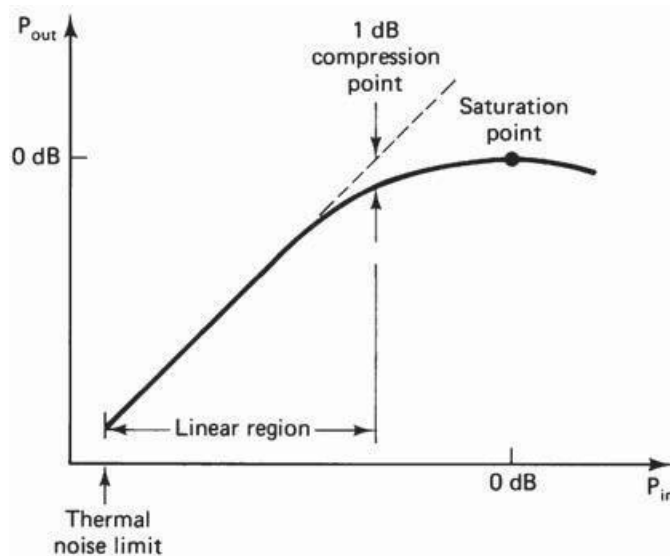

Figure 2.14 Power transfer characteristics of a TWT. The saturation point is used as 0-dB reference for both input and output.

At low-input powers, the output-input power relationship is linear; that is, a given decibel change in input power will produce the same decibel change in output power. At higher power inputs, the output power saturates, the point of maximum power output being known as the *saturation point*.

The saturation point is a very convenient reference point, and input and output quantities are usually referred to it. The linear region of the TWT is defined as the region bound by the thermal noise limit at the low end and by what is termed the *1-dB compression point* at the upper end. This is the point where the actual transfer curve drops

2.7. Satellite uplink and downlink Analysis and Design

2.7.1 Introduction

This chapter describes how the link-power budget calculations are made. These calculations basically relate two quantities, the transmit power and the receive power, and show in detail how the difference between these two powers is accounted for.

Link-budget calculations are usually made using decibel or decilog quantities. These are explained in App. G. In this text [square] brackets are used to denote decibel quantities using the basic power definition.

Where no ambiguity arises regarding the units, the abbreviation dB is used. For example, Boltzmann's constant is given as 228.6 dB, although, strictly speaking, this should be given as 228.6 deci logs relative to 1 J/K.

2.7.2 Equivalent Isotropic Radiated Power

A key parameter in link-budget calculations is the *equivalent isotropic radiated power*, conventionally denoted as EIRP. From Eqs. (2.1) and (2.2), the maximum power flux density at some distance r from a transmitting antenna of gain G is

$$P_r = \frac{GP}{4\pi^2 r^2}$$

An isotropic radiator with an input power equal to GP would produce the same flux density. Hence, this product is referred to as the EIRP, or EIRP is often expressed in decibels relative to 1 W, or dBW. Let P_S be in watts; then $[EIRP] = [P_S] + [G]$ dB, where $[P_S]$ is also in dBW and $[G]$ is in dB.

2.7.3 Transmission Losses

The [EIRP] may be thought of as the power input to one end of the transmission link, and the problem is to find the power received at the other end. Losses will occur along the way, some of which are constant.

Other losses can only be estimated from statistical data, and some of these are dependent on weather conditions, especially on rainfall.

The first step in the calculations is to determine the losses for *clear-weather* or *clear-sky conditions*. These calculations take into account the losses, including those calculated on a statistical basis, which do not vary significantly with time. Losses which are weather-related, and other losses which fluctuate with time, are then allowed for by introducing appropriate *fade margins* into the transmission equation.

Free-space transmission:

As a first step in the loss calculations, the power loss resulting from the spreading of the signal in space must be determined.

Feeder losses:

www.EnggTree.com

Losses will occur in the connection between the receive antenna and the receiver proper. Such losses will occur in the connecting waveguides, filters, and couplers. These will be denoted by RFL, or [RFL] dB, for *receiver feeder losses*.

Antenna misalignment losses

When a satellite link is established, the ideal situation is to have the earth station and satellite antennas aligned for maximum gain, as shown in Fig. There are two possible sources of off-axis loss, one at the satellite and one at the earth station, as shown in Fig.

The off-axis loss at the satellite is taken into account by designing the link for operation on the actual satellite antenna contour; this is described in more detail in later sections. The off-axis loss at the earth station is referred to as the *antenna pointing loss*. Antenna pointing losses are usually only a few tenths of a decibel;

In addition to pointing losses, losses may result at the antenna from misalignment of the polarization direction (these are in addition to the polarization losses described in Chap. 5). The polarization misalignment losses

are usually small, and it will be assumed that the antenna misalignment losses, denoted by [AML], include both pointing and polarization losses resulting from antenna misalignment. It should be noted

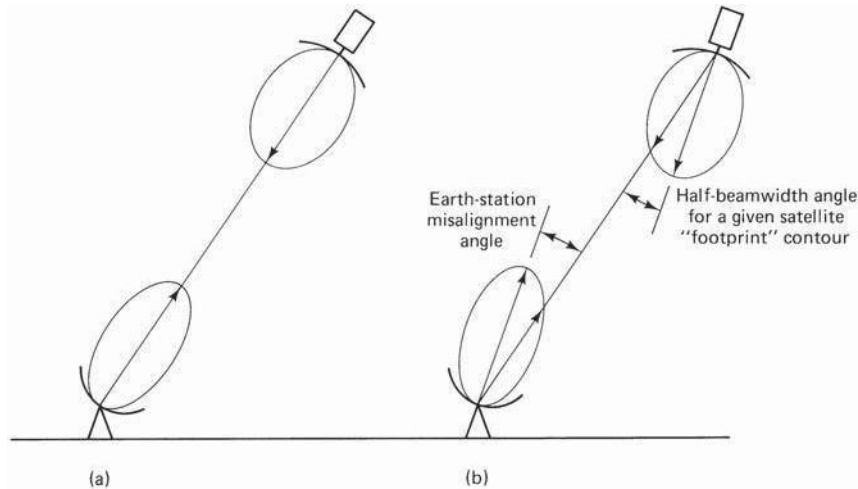

Figure 2.15 (a) Satellite and earth-station antennas aligned for maximum gain; (b) earth station situated on a given satellite “footprint,” and earth-station antenna misaligned.

www.EnggTree.com

2.8 The Link-Power Budget Equation

Now that the losses for the link have been identified, the power at the receiver, which is the power output of the link, may be calculated simply as $[EIRP] - [LOSSES] + [G_R]$, where the last quantity is the receiver antenna gain. Note carefully that decibel addition must be used.

The major source of loss in any ground-satellite link is the free-space spreading loss [FSL], the basic link-power budget equation taking into account this loss only. However, the other losses also must be taken into account, and these are simply added to [FSL]. The losses for clear-sky conditions are

$[LOSSES] = [FSL] + [RFL] + [AML] + [AA] - [PL]$ equation for the received power is then

$$[P_R] = [EIRP] + [G_R] - [LOSSES]$$

where [P_R] received power, dBW

[EIRP] - equivalent isotropic radiated power, dBW [FSL] free-space spreading loss, dB

[RFL] - receiver feeder loss, dB

[AML] - antenna misalignment loss, dB

[AA] - atmospheric absorption loss, dB [PL] polarization mismatch loss, dB

2.9 Amplifier noise temperature

Consider first the noise representation of the antenna and the *low noise amplifier* (LNA) shown in Fig. 2.15.

The available power gain of the amplifier is denoted as G , and the noise power output, as P_{no} .

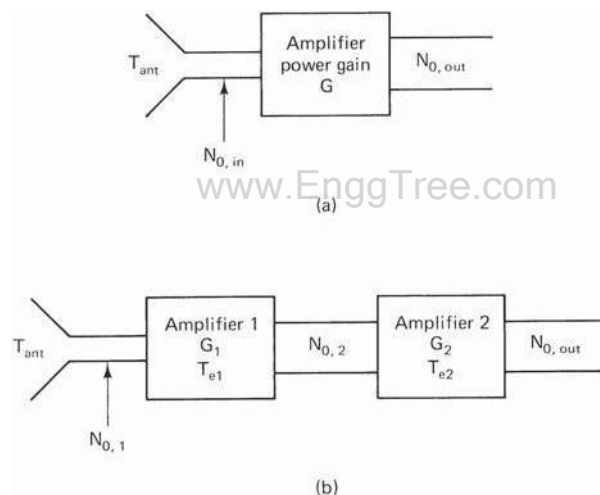

Figure 2.15 LNA Amplifier gain

For the moment we will work with the noise power per unit bandwidth, which is simply noise energy in joules as shown by Eq.

The input noise energy coming from the antenna is

$$N_{0, ant} = kT_{ant}$$

2.10 The Uplink

The uplink of a satellite circuit is the one in which the earth station is transmitting the signal and the satellite is receiving it specifically that the uplink is being considered.

$$\frac{C}{N} = [EIRP] - [LOSSES] + [k]$$

In this Eq the values to be used are the earth station EIRP, the satellite receiver feeder losses, and satellite receiver G/T . The free-space loss and other losses which are frequency-dependent are calculated for the uplink frequency.

2.10.1 Input backoff

Number of carriers are present simultaneously in a TWTA, the operating point must be backed off to a linear portion of the transfer characteristic to reduce the effects of inter modulation distortion. Such multiple carrier operation occurs with *frequency-division multiple access* (FDMA), which is described in Chap. 14. The point to be made here is that *backoff* (BO) must be allowed for in the link-budget calculations.

www.EnggTree.com

Suppose that the saturation flux density for single-carrier operation is known. Input BO will be specified for multiple-carrier operation, referred to the single-carrier saturation level. The earth-station EIRP will have to be reduced by the specified BO, resulting in an uplink value of

$$[EIRP]_U = [EIRP]_S + [BO]_i$$

2.10.2 The earth station HPA

The earth station HPA has to supply the radiated power plus the transmit feeder losses, denoted here by TFL, or [TFL] dB. These include waveguide, filter, and coupler losses between the HPA output and the transmit antenna. Referring back to Eq. (12.3), the power output of

The earth station itself may have to transmit multiple carriers, and its output also will require back off, denoted by [BO]_{HPA}. The earth station HPA must be rated for a saturation power output given by

$$[P_{HPA, \text{sat}}] = [P_{HPA}] + [BO]_{HPA}$$

2.11 Downlink

The downlink of a satellite circuit is the one in which the satellite is transmitting the signal and the earth station is receiving it. Equation can be applied to the downlink, but subscript D will be used to denote specifically that the downlink is being considered. Thus Eq. becomes

$$\frac{C}{N} = [EIRP] - [LOSSES] + []$$

In Eq. the values to be used are the satellite EIRP, the earth-station receiver feeder losses, and the earth-station receiver G/T . The free space and other losses are calculated for the downlink frequency. The resulting carrier-to-noise density ratio given by Eq. is that which appears at the detector of the earth station receiver.

2.11.1 Output back-off

Where input BO is employed as described in a corresponding output BO must be allowed for in the satellite EIRP. As the curve of Fig. 2.16 shows, output BO is not linearly related to input BO. A rule of thumb, frequently used, is to take the output BO as the point on the curve which is 5 dB below the extrapolated linear portion, as shown in Fig. 12.7. Since the linear portion gives a 1:1 change in decibels, the relationship between input and output BO is $[BO]_0 = [BO]_i - 5 \text{ dB}$. For example, with an input BO of $[BO]_i = 11 \text{ dB}$, the corresponding output BO is $[BO]_0$

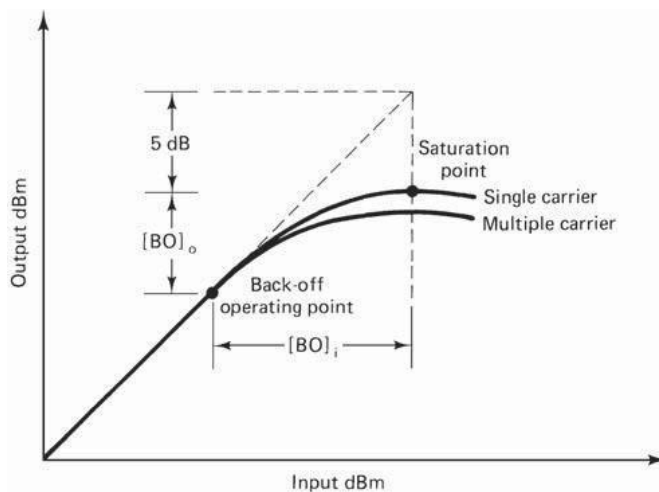

Figure 2.16 Input and output back-off relationship for the satellite traveling-wave-tube amplifier; $[BO]_i = [BO]_0 + 5 \text{ dB}$.

2.11.2 Effects of Rain

In the C band and, more especially, the Ku band, rainfall is the most significant cause of signal fading. Rainfall results in attenuation of radio waves by scattering and by absorption of energy from the wave.

Rain attenuation increases with increasing frequency and is worse in the Ku band compared with the C band.

This produces a depolarization of the wave; in effect, the wave becomes elliptically polarized. This is true for both linear and circular polarizations, and the effect seems to be much worse for circular polarization (Freeman, 1981).

The C/N_0 ratio for the downlink alone, not counting the P_{NU} contribution, is P_R/P_{ND} , and the combined C/N_0 ratio at the ground receiver is

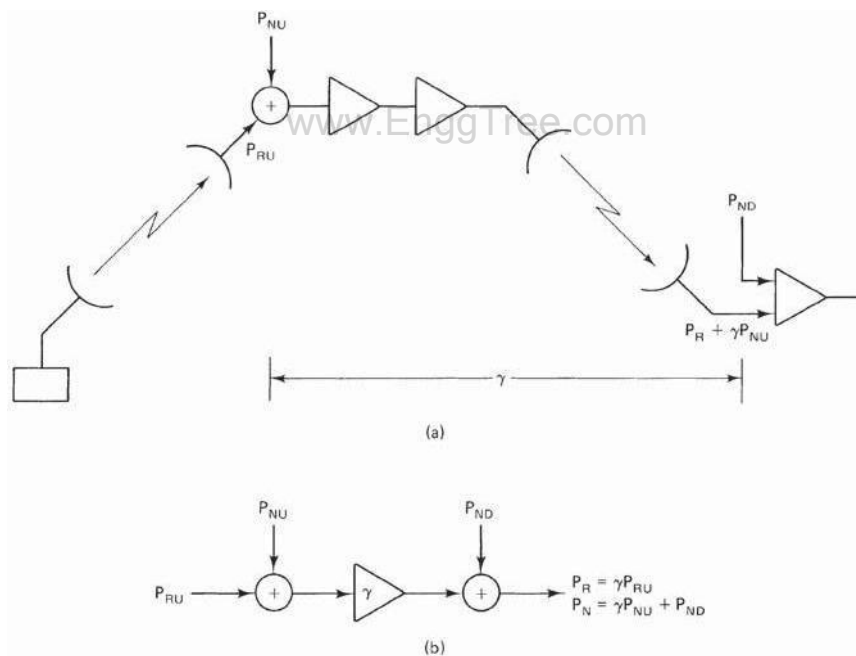

Figure 2.17 (a) Combined uplink and downlink; (b) power flow diagram

The reason for this reciprocal of the sum of the reciprocals method is that a single signal power is being transferred through the system, while the various noise powers, which are present are additive. Similar reasoning applies to the carrier-to-noise ratio, C/N .

2.12. inter modulation and interference

Intermodulation interference is the undesired combining of several signals in a nonlinear device, producing new, unwanted frequencies, which can cause interference in adjacent receivers located at repeater sites.

Not all interference is a result of intermodulation distortion. It can come from co-channel interference, atmospheric conditions as well as man-made noise generated by medical, welding and heating equipment.

Most intermodulation occurs in a transmitter's nonlinear power amplifier (PA). The next most common mixing point is in the front end of a receiver. Usually it occurs in the unprotected first mixer of older model radios or in some cases an overdriven RF front-end amp.

Intermodulation can also be produced in rusty or corroded tower joints, guy wires, turnbuckles and anchor rods or any nearby metallic object, which can act as a nonlinear "mixer/rectifier" device.

2.13. Propagation Characteristics and Frequency considerations

2.13.1 Introduction www.EnggTree.com

A number of factors resulting from changes in the atmosphere have to be taken into account when designing a satellite communications system in order to avoid impairment of the wanted signal.

Generally, a margin in the required carrier-to-noise ratio is incorporated to accommodate such effects.

2.13.2 Radio Noise

Radio noise emitted by matter is used as a source of information in radio astronomy and in remote sensing. Noise of a thermal origin has a continuous spectrum, but several other radiation mechanisms cause the emission to have a spectral-line structure. Atoms and molecules are distinguished by their different spectral lines.

For other services such as satellite communications noise is a limiting factor for the receiving system; generally, it is inappropriate to use receiving systems with noise temperatures which are much less than those specified by the minimum external noise.

From about 30 MHz to about 1 GHz cosmic noise predominates over atmospheric noise except during local thunderstorms, but will generally be exceeded by man-made noise in populated areas.

In the bands of strong gaseous absorption, the noise temperature reaches maximum values of some 290 K. At times, precipitation will also increase the noise temperature at frequencies above 5 GHz.

Figure 6.1 gives an indication of sky noise at various elevation angles and frequencies.

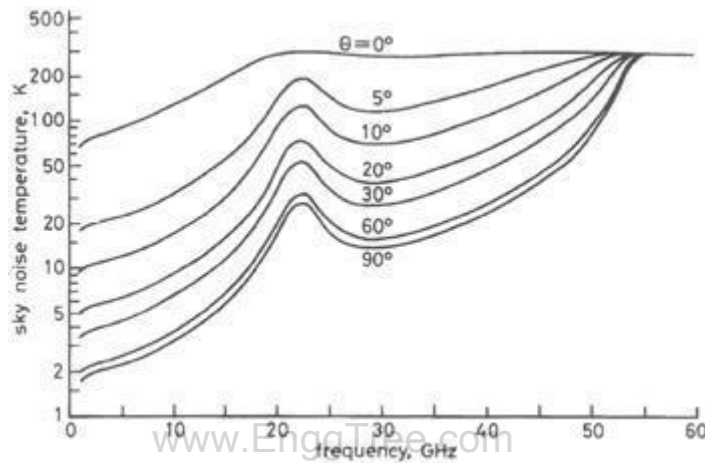

Figure 2.18 Sky-Noise Temperature for Clear Air

2.14. System reliability and design lifetime

2.14.1 System reliability

Satellites are designed to operate dependably throughout their operational life, usually a number of years.

This is achieved through stringent quality control and testing of parts and subsystems before they are used in the construction of the satellite.

Redundancy of key components is often built in so that if a particular part or subassembly fails, another can perform its functions.

In addition, hardware and software on the satellite are often designed so that ground controllers can reconfigure the satellite to work around a part that has failed.

2.14.2. Design lifetime

The Milstar constellation has demonstrated exceptional reliability and capability, providing vital protected communications to the warfighter,” said Kevin Bilger, vice president and general manager, Global Communications Systems, Lockheed Martin Space Systems in Sunnyvale.

“Milstar’s robust system offers our nation worldwide connectivity with flexible, dependable and highly secure satellite communications.”

The five-satellite Milstar constellation has surpassed 63 years of combined successful operations, and provides a protected, global communication network for the joint forces of the U.S. military. In addition, it can transmit voice, data, and imagery, and offers video conferencing capabilities.

The system is the principal survivable, enduring communications structure that the President, the Secretary of Defense and the Commander, U.S. Strategic Command use to maintain positive command and control of the nation's strategic forces.

www.EnggTree.com

In addition to this 10-year milestone for Flight-5, each of the first two Milstar satellites have been on orbit for over 16 years – far exceeding their 10-year design life.

The next-generation Lockheed Martin-built Advanced EHF satellites, joining the Milstar constellation, provide five times faster data rates and twice as many connections, permitting transmission of strategic and tactical military communications, such as real-time video, battlefield maps and targeting data. Advanced EHF satellites are designed to be fully interoperable and backward compatible with Milstar.

Headquartered in Bethesda, Md., Lockheed Martin is a global security company that employs about 123,000 people worldwide and is principally engaged in the research, design, development, manufacture, integration and sustainment of advanced technology systems, products and services. The Corporation's net sales for 2011 were \$46.5 billion.

APPLICATIONS

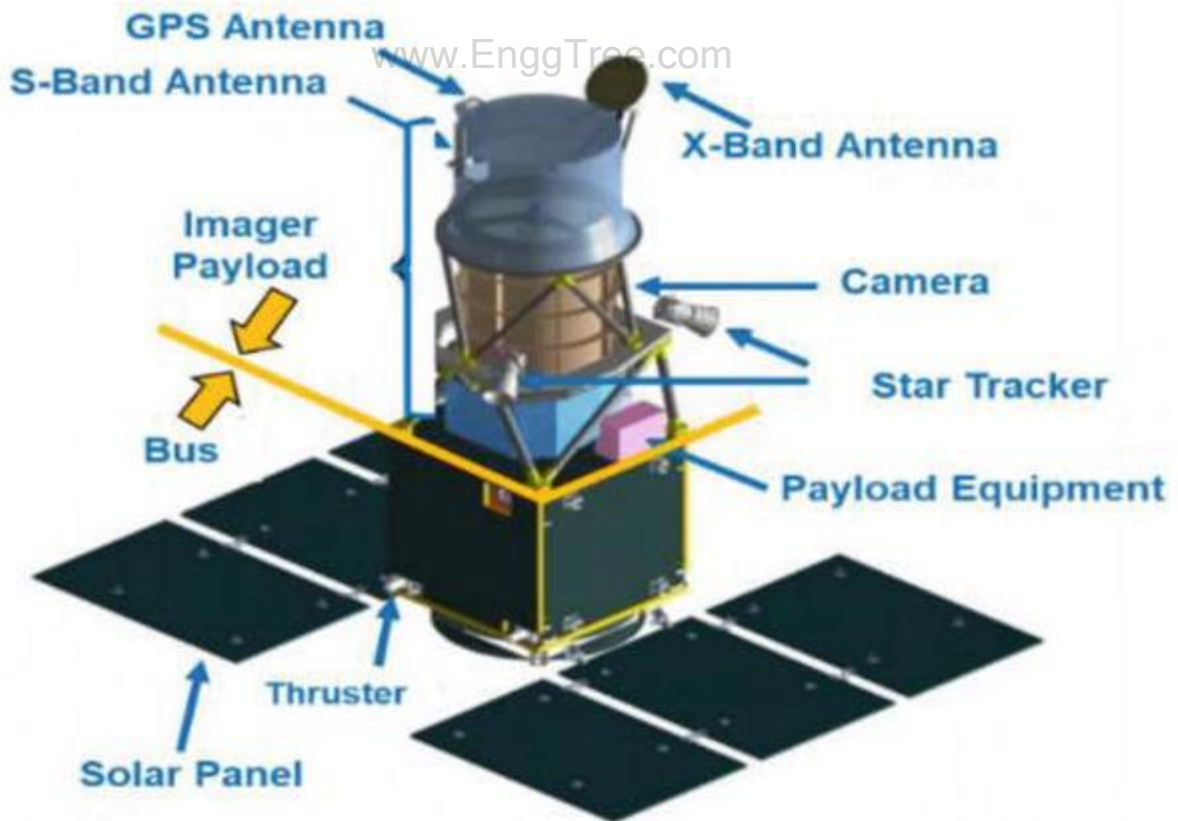
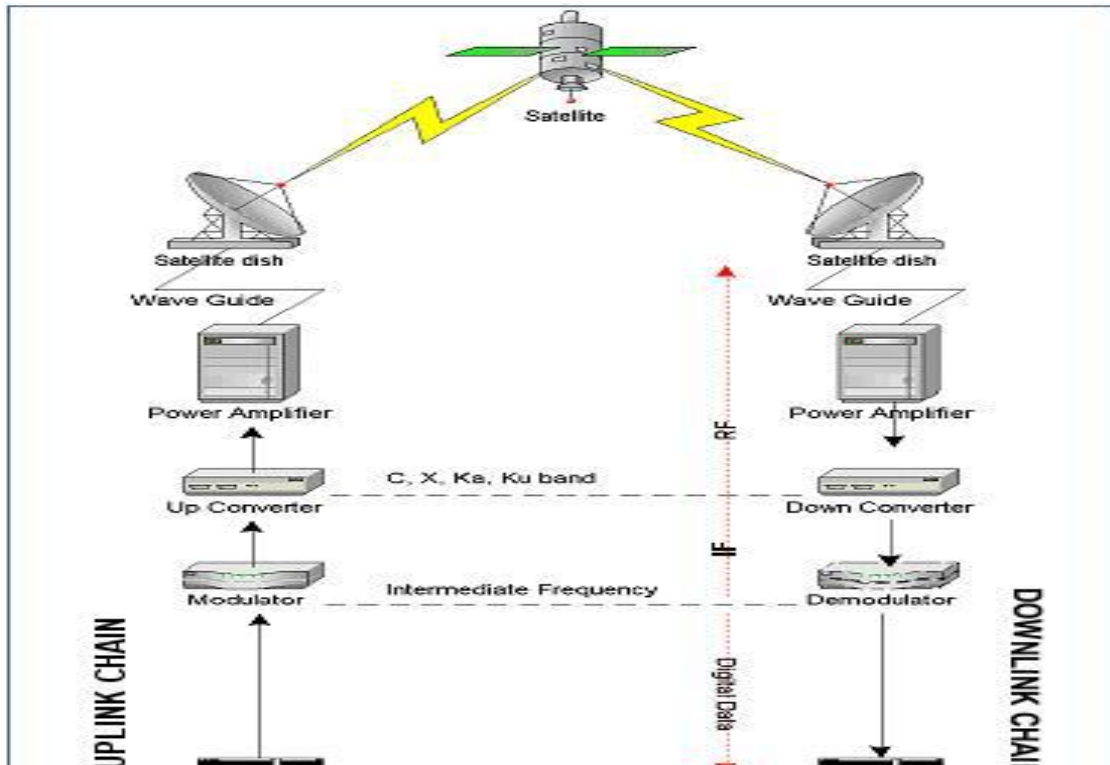

Figure typical satellite with bus and payload separation

POST TEST MCQ

1. The lowest frequency used in satellite communications is _____ GHz.
 - a) **0.8**
 - b) 3
 - c) 18
 - d) 30

2. For satellite transmission, analog signals may be converted into digital form with the help of _____.
 - a) modem
 - b) transponder
 - c) **codec**
 - d) compandor

3. Geosynchronous satellites are always launched in the equatorial plane because it is the only plane which provides _____
 - a) 24-hour orbit
 - b) stationary satellite
 - c) **global communication**
 - d) zero-gravity environs

4. The traffic-handling capacity of an Earth station on the uplink depends on _____.
 - a) its EIRP
 - b) satellite antenna gain
 - c) noise associated with the satellite
 - d) **all of the above**

5. Phase modulation is commonly-used for data transmission mainly because
 - a) phase can be varied from $+180^\circ$ to 180°
 - b) **it is resistant to the effects of noise**
 - c) demodulation is very easy
 - d) it gives highest data rates that can be transmitted over a given channel

6. Most of the communication satellites are stationed to the West of their service areas order to reduce their

- a) eclipse period
- b) loss of power
- c) battery power provision**
- d) mass of station-keeping fuel

7. The echo heard by a telephone user on a satellite channel can be removed by using

- a) a vocoder
- b) a multiplexer
- c) echo suppressor**
- d) digital techniques

8. A satellite link uses different frequencies for receiving and transmitting in order to

- a) avoid interference from terrestrial microwave links
- b) avoid interference between its powerful transmitted signal and weak in coming signal**
- c) minimise free-space losses
- d) maximise antenna gain

www.EnggTree.com

9. System satellites orbit the Earth once in

- a) 24 hours**
- b) 12 hours
- c) 1 hour
- d) 6 hours

10. A few minutes disturbance in space communications occurs twice a year during Sunblinding when _____ are in line.

- a) Sun and satellite
- b) Sun and Earth station
- c) Satellite and Earth station
- d) Sun, satellite and Earth station**

11. In the context of error detection in satellite transmission, ARQ stands for

- a) **Automatic Repeat Request**
- b) Automatic Relay Request
- c) Accelerated Recovery Request
- d) Automatic Radiation Quenching

12. To cover all inhabited regions of the Earth, the number of geosynchronous communication satellites required

- a) 5
- b) **3**
- c) 10
- d) 2

13. A modem is

- a) a form of commutator
- b) a device for digitizing speech
- c) a circuit used for suppressing microwave interference
- d) **an electronic circuit which carries out modulation and demodulation of a carrier frequency**

14. A typical signal strength received from a geosynchronous communication satellite is of the order of a few

- a) milliwatts
- b) kilowatts
- c) **picowatts**
- d) watts

15. A telephone user while talking to a person via a satellite has to wait for reply for about _____ millisecond.

- a) 100
- b) 270
- c) 470
- d) **540**

CONCLUSION

- ❖ In this unit we describe the Spacecraft Technology.
- ❖ The Satellite Uplink and Downlink Analysis and Design were discussed.
- ❖ The Link Power Budget, C/N calculation and G/T ratio-Performance were elaborated.

REFERENCES

1. Wilbur L.Pritchard, Hendri G. Suyderhoud, Robert A. Nelson, "Satellite Communication Systems Engineering", Prentice Hall/Pearson, 2007.
2. N. Agarwal, "Design of Geosynchronous Space Craft", Prentice Hall, 1986.
3. Bruce R. Elbert, "Satellite Communication Applications", Hand Book, Artech House Bostan London,1997.
4. Tri T. Ha, "Digital Satellite Communication", II nd edition, 1990.
5. Robert G. Winch, "Telecommunication Transmission Systems", Mc Graw-Hill Book Co., 1983.
6. Brian Ackroyd, "World Satellite Communication and earth station Design", BSP professional Books, 1990.
7. G.B.Bleazard, "Introducing Satellite communications", NCC Publication, 1985.
8. M.Richharia, "Satellite Communication Systems-Design Principles", Macmillan 2003.
9. Emanuel Fthenakis, "Manual of Satellite Communications", Mc Graw Hill Book Co., 1984.

ASSIGNMENT

1. Explain the difference types of transmission losses in satellite communication with necessary expression. Write the link power budget equation.
2. Discuss the different types of noise and their significance in the design of a satellitelink with necessary expression.
3. Explain the following: input backoff, output backoff, earth station HPA andcombined uplink and downlink. C/N ratio.
4. Explain wideband receiver operation with neat diagram ORB.
5. Explain thermal control system. With a neat sketch,
6. Explain Telemetry, Tracking and command subsystem.

SATELLITE COMMUNICATION

www.EnggTree.com

UNIT III EARTH SEGMENT

UNIT III EARTH SEGMENT

AIM & OBJECTIVE

- ❖ To understand the basics of earth segment.
- ❖ To understand the Indoor UNIT for analog (FM) TV.
- ❖ To analyze the Terrestrial Interface.
- ❖ To understand the Antenna Gain.

PRE TEST MCQ

1. To make antenna more directional, either its size must be increased or
 - a) the number of its feed horns must be increased
 - b) the frequency of its transmission must be increased**
 - c) its effective isotropic radiated power (EIRP) must be increased
 - d) its footprint must be increased

2. The number of days when Earth's shadow falls on a geosynchronous satellite is
 - a) 88**
 - b) 277
 - c) 5
 - d) 10

3. A helical antenna is used for satellite tracking because of _____
 - a) Circular polarization**
 - b) Maneuverability
 - c) Beamwidth
 - d) Gain

3.1 Earth Station Technology

The earth segment of a satellite communications system consists of the transmit and receive earth stations. The simplest of these are the home *TV receive-only* (TVRO) systems, and the most complex are the terminal stations used for international communications networks. Also included in the earth segment are those stations which are on ships at sea, and commercial and military land and aeronautical mobile stations.

As mentioned in earth stations that are used for logistic support of satellites, such as providing the *telemetry, tracking, and command* (TT&C) functions, are considered as part of the space segment.

3.1.1 Terrestrial Interface

Earth station is a vital element in any satellite communication network. The function of an earth station is to receive information from or transmit information to, the satellite network in the most cost-effective and reliable manner while retaining the desired signal quality. The design of earth station configuration depends upon many factors and its location. But it is fundamentally governed by its

Location which are listed below,

- In land
- On a ship at sea
- Onboard aircraft

The factors are

- Type of services
- Frequency bands used
- Function of the transmitter
- Function of the receiver
- Antenna characteristics

3.1.2 Transmitter and Receiver

Any earth station consists of four major subsystems

- Transmitter
- Receiver
- Antenna • Tracking equipment

Two other important subsystems are

- Terrestrial interface equipment
- Power supply

The earth station depends on the following parameters

- Transmitter power
- Choice of frequency
- Gain of antenna
- Antenna efficiency
- Antenna pointing accuracy
- Noise temperature

The functional elements of a basic digital earth station are shown in the below figure

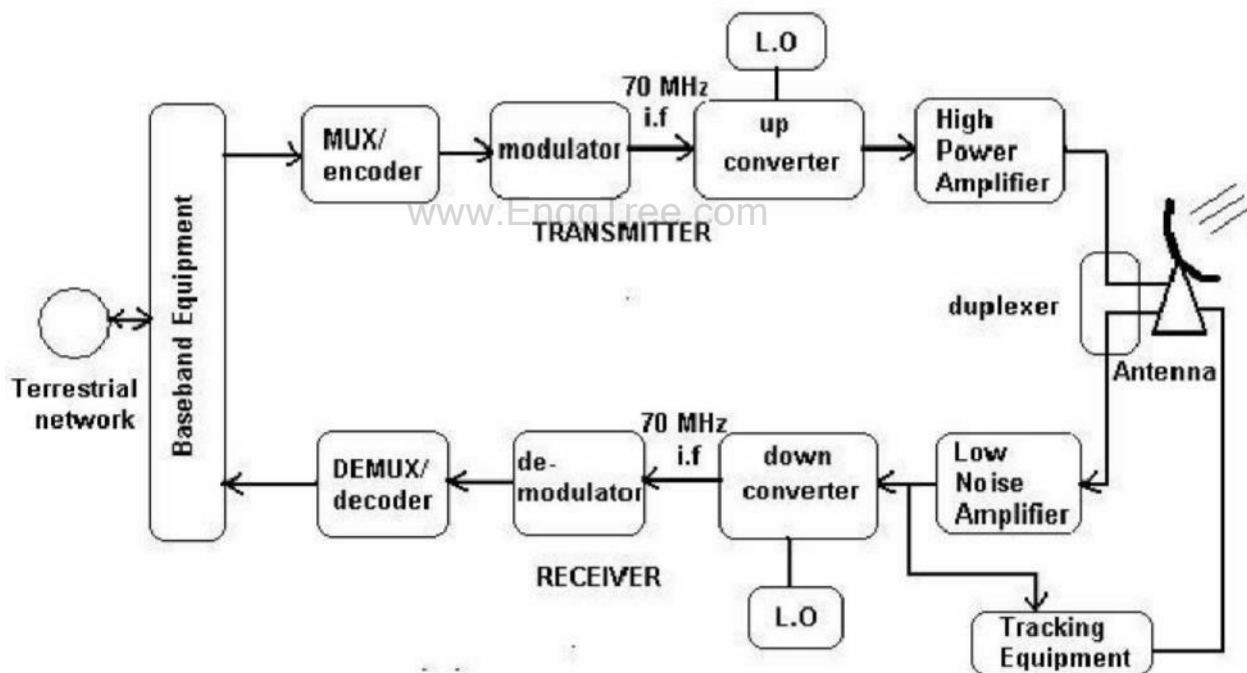

Figure 3.1 Transmitter- Receiver

Digital information in the form of binary digits from terrestrial networks enters earth station and is then processed (filtered, multiplexed, formatted etc.) by the base band equipment.

- The encoder performs error correction coding to reduce the error rate, by introducing extra digits into digital stream generated by the base band

equipment. The extra digits carry information.

- In satellite communication, I.F carrier frequency is chosen at 70 MHz for communication using a 36 MHz transponder bandwidth and at 140 MHz for a transponder bandwidth of 54 or 72 MHz.

- On the receive side, the earth station antenna receives the low-level modulated R.F carrier in the downlink frequency spectrum.

- The low noise amplifier (LNA) is used to amplify the weak received signals and improve the signal to Noise ratio (SNR). The error rate requirements can be met more easily.

- R.F is to be reconverted to I.F at 70 or 140 MHz because it is easier design a demodulation to work at these frequencies than 4 or 12 GHz.

- The demodulator estimate which of the possible symbols was transmitted based on observation of the received if carrier.

- The decoder performs a function opposite that of the encoder. Because the sequence of symbols recovered by the demodulator may contain errors, the decoder must use the uniqueness of the redundant digits introduced by the encoder to correct the errors and recover information-bearing digits.

- The information stream is fed to the base-band equipment for processing for delivery to the terrestrial network.

- The tracking equipments track the satellite and align the beam towards it to facilitate communication.

3.1.3. Earth Station Tracking System

Tracking is essential when the satellite drift, as seen by an earth station antenna is a significant fraction of an earth station's antenna beam width.

An earth station's tracking system is required to perform some of the functions such as

- i) Satellite acquisition
- ii) Automatic tracking
- iii) Manual tracking
- iv) Program tracking.

3.2 Antenna Systems

The antenna system consist of

- ❖ Feed System
- ❖ Antenna Reflector
- ❖ Mount
- ❖ Antenna tracking System

3.2.1 FEED SYSTEM

The feed along with the reflector is the radiating/receiving element of electromagnetic waves. The reciprocity property of the feed element makes the earth station antenna system suitable for transmission and reception of electromagnetic waves.

The way the waves coming in and going out is called feed configuration Earth Station feed systems most commonly used in satellite communication are:

- i) Axi-Symmetric Configuration
- ii) Asymmetric Configuration

i) Axi-Symmetric Configuration

www.EnggTree.com

In an axi-symmetric configuration the antenna axes are symmetrical with respect to the reflector, which results in a relatively simple mechanical structure and antenna mount.

Primary Feed

In primary, feed is located at the focal point of the parabolic reflector. Many dishes use only a single bounce, with incoming waves reflecting off the dish surface to the focus in front of the dish, where the antenna is located. When the dish is used to transmit, the transmitting antenna at the focus beams waves toward the dish, bouncing them off to space. This is the simplest arrangement.

Cassegrain

Many dishes have the waves make more than one bounce. This is generally called as folded systems. The advantage is that the whole dish and feed system is more compact. There are several folded configurations, but all have at least one secondary reflector also called a sub reflector, located out in front of the dish to redirect the waves.

A common dual reflector antenna called Cassegrain has a convex sub reflector positioned in front of the main dish, closer to the dish than the focus. This sub reflector bounces back the waves back toward a feed located on the main dish's center, sometimes behind a hole at the center of the main dish. Sometimes there are even more sub reflectors behind the dish to direct the waves to the feed for convenience or compactness.

Gregorian

This system has a concave secondary reflector located just beyond the primary focus. This also bounces the waves back toward the dish.

ii)Asymmetric Configuration

Offset or Off-axis feed

The performance of an axi-symmetric configuration is affected by the blockage of the aperture by the feed and the sub reflector assembly. The result is a reduction in the antenna efficiency and an increase in the side lobe levels. The asymmetric configuration can remove this limitation..This is achieved by off - setting the mounting arrangement of the feed so that it does not obstruct the main beam. As a result ,the efficiency and side lobe level performance are improved.

3.2.2 ANTENNA REFLECTOR

Mostly parabolic reflectors are used as the main antenna for the earth stations because of the high gain available from the reflector and the ability of focusing a parallel beam into a point at the focus where the feed,i.e., the receiving/radiating element is located .For large antenna system more than one reflector surfaces may be used in as in the cassegrain antenna system.

Earth stations are also classified on the basis of services for example:

- 1.Two way TV ,Telephony and data
2. Two way TV
- 3.TV receive only and two way telephony and data
- 4.Two way data

From the classifications it is obvious that the technology of earth station will vary considerably on the performance and the service requirements of earth station

For mechanical design of parabolic reflector the following parameters are required to be considered:

- ❖ Size of the reflector
- ❖ Focal Length /diameter ratio
- ❖ RMS error of main and sub reflector
- ❖ Pointing and tracking accuracies
- ❖ Speed and acceleration
- ❖ Type of mount
- ❖ Coverage Requirement

Wind Speed

The size of the reflector depends on transmit and receive gain requirement and beamwidth of the antenna. Gain is directly proportional to the antenna diameter whereas the beamwidth is inversely proportional to the antenna diameter .for high inclination angle of the satellite ,the tracking of the earth station becomes necessary when the beamwidth is too narrow.

The gain of the antenna is given by

$$\text{Gain} = (\eta 4\pi A_{\text{eff}}) / \lambda^2$$

Where A_{eff} is the aperture

λ is wave length

η is efficiency of antenna system

For a parabolic antenna with circular aperture diameter D , the gain of the antenna is :

$$\begin{aligned}\text{Gain} &= (\eta 4\pi / \lambda^2) (\pi D^2 / 4) \\ &= \eta (\pi D / \lambda)^2\end{aligned}$$

The overall efficiency of the antenna is the net product of various factors such as

1. Cross Polarization
2. Spill over
3. Diffraction
4. Blockage
5. Surface accuracy
6. Phase error
7. Illumination

In the design of feed, the ratio of focal length F to the diameter of the

reflector D of the antenna system control the maximum angle subtended by the reflector surface on the focal point. Larger the F/D ratio larger is the aperture illumination efficiency and lower the cross polarization.

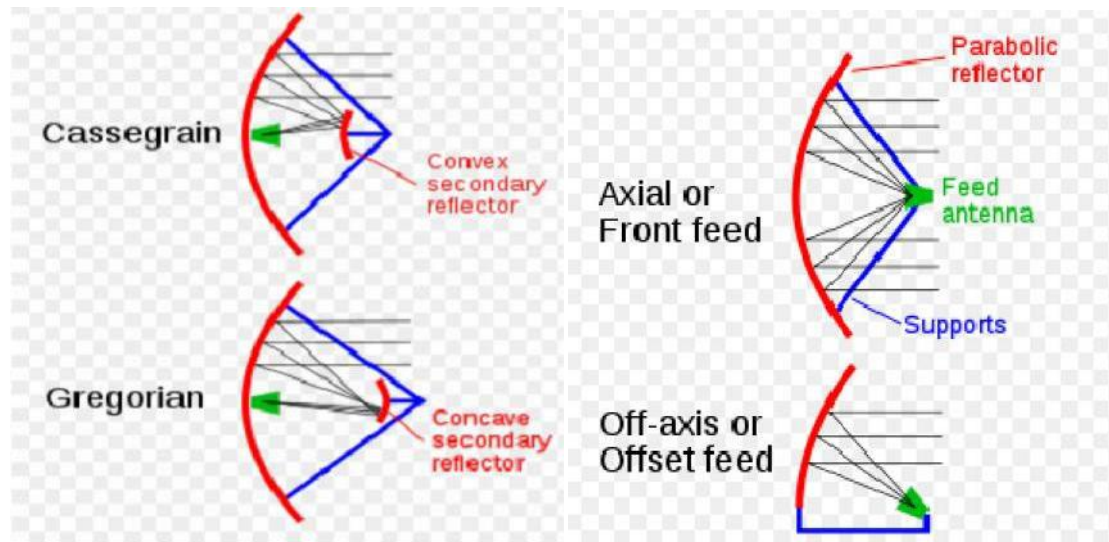

Figure 3.2 Antenna sub systems

3.2.3 ANTENNA MOUNT www.EnggTree.com

Type of antenna mount is determined mainly by the coverage requirement and tracking requirements of the antenna systems. Different types of mounts used for earth station antenna are:

i) **The Azimuth –elevation mount**

This mount consists of a primary vertical axis. Rotation around this axis controls the azimuth angle. The horizontal axis is mounted over the primary axis, providing the elevation angle control.

ii) **The X-Y mount**

It consists of a horizontal primary axis (X-axis) and a secondary axis (Y-axis) and at right angles to it. Movement around these axes provides necessary steering.

3.2.4 ANTENNA TRACKING SYSTEM

Tracking is essential when the satellite drift, as seen by an earth station antenna is a significant fraction of an earth station's antenna beam width.

An earth station's tracking system is required to perform some of the functions such as

- i) Satellite acquisition
- ii) Automatic tracking
- iii) Manual tracking
- iv) Program tracking.

Recent Tracking Techniques

There have been some interesting recent developments in auto-track techniques which can potentially provide high accuracies at a low cost.

In one proposed technique the sequential lobing technique has been implemented by using rapid electronic switching of a single beam which effectively approximates simultaneous lobbing.

3.3 Receive-Only Home TV Systems

Planned broadcasting directly to home TV receivers takes place in the Ku (12-GHz) band. This service is known as *direct broadcast satellite* (DBS) service.

There is some variation in the frequency bands assigned to different geographic regions. In the Americas, for example, the down-link band is 12.2 to 12.7 GHz.

The comparatively large satellite receiving dishes [ranging in diameter from about 1.83 m (6 ft) to about 3-m (10 ft) in some locations], which may be seen in some "backyards" are used to receive downlink TV signals at C band (4 GHz).

Originally such downlink signals were never intended for home reception but for network relay to commercial TV outlets (VHF and UHF TV broadcast stations and cable TV "head-end" studios).

3.3.1 The Indoor unit

Equipment is now marketed for home reception of C-band signals, and some manufacturers provide dual C-band/Ku-band equipment. A single mesh type reflector may be used which focuses the signals into a dual feed-horn, which has two separate outputs, one for the C-band signals and one for the Ku-band signals.

Much of television programming originates as *first generation signals*, also known as *master broadcast quality signals*.

These are transmitted via satellite in the C band to the network head-end stations, where they are retransmitted as compressed digital signals to cable and direct broadcast satellite providers.

- Another of the advantages, claimed for home C-band systems, is the larger number of satellites available for reception compared to what is available for direct broadcast satellite systems.
- Although many of the C-band transmissions are scrambled, there are free channels that can be received, and what are termed “wild feeds.”
www.EnggTree.com
- These are also free, but unannounced programs, of which details can be found in advance from various publications and Internet sources.
- C-band users can also subscribe to pay TV channels, and another advantage claimed is that subscription services are cheaper than DBS or cable because of the multiple-source programming available.
- The most widely advertised receiving system for C-band system appears to be 4DTV manufactured by Motorola.

This enables reception of

- ❖ Free, analog signals and “wild feeds”
- ❖ Video Cipher II plus subscription services
- ❖ Free Digi Cipher 2 services
- ❖ Subscription DigiCipher 2 services

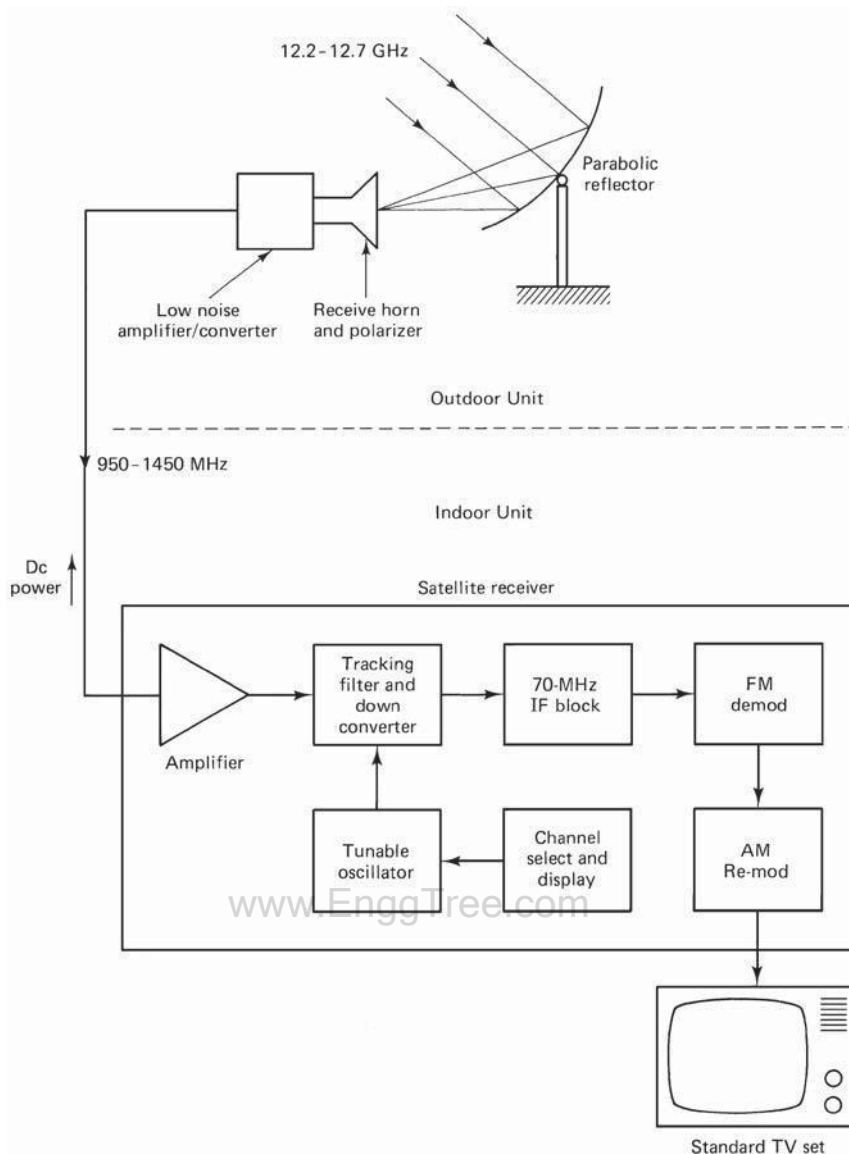

Figure 3.3 TVRO System block diagrams

3.3.2 The outdoor unit

This consists of a receiving antenna feeding directly into a low-noise amplifier/converter combination. A parabolic reflector is generally used, with the receiving horn mounted at the focus. A common design is to have the focus directly in front of the reflector, but for better interference rejection, an offset feed may be used as shown.

Comparing the gain of a 3-m dish at 4 GHz with a 1-m dish at 12 GHz, the ratio D/λ equals 40 in each case, so the gains will be about equal. Although the free-space losses are much higher at 12 GHz compared with 4 GHz.

The downlink frequency band of 12.2 to 12.7 GHz spans a range of 500 MHz, which accommodates 32 TV/FM channels, each of which is 24-MHz wide. Obviously, some overlap occurs between channels, but these are alternately polarized *left-hand circular* (LHC) and *right-hand circular* (RHC) or vertical/horizontal, to reduce interference to acceptable levels. This is referred to as *polarization interleaving*. A polarizer that may be switched to the desired polarization from the indoor control unit is required at the receiving horn.

The receiving horn feeds into a *low-noise converter* (LNC) or possibly a combination unit consisting of a *low-noise amplifier* (LNA) followed by a converter.

The combination is referred to as an LNB, for *low-noise block*. The LNB provides gain for the broadband 12-GHz signal and then converts the signal to a lower frequency range so that a low-cost coaxial cable can be used as feeder to the indoor unit.

The signal fed to the indoor unit is normally a wideband signal covering the range 950 to 1450 MHz. This is amplified and passed to a tracking filter which selects the desired channel, as shown in Fig.

www.EnggTree.com

As previously mentioned, polarization interleaving is used, and only half the 32 channels will be present at the input of the indoor unit for any one setting of the antenna polarizer. This eases the job of the tracking filter, since alternate channels are well separated in frequency.

The selected channel is again down converted, this time from the 950- to 1450-MHz range to a fixed intermediate frequency, usually 70 MHz although other values in the *very high frequency* (VHF) range are also used.

The 70-MHz amplifier amplifies the signal up to the levels required for demodulation. A major difference between DBS TV and conventional TV is that with DBS, frequency modulation is used, whereas with conventional TV, amplitude modulation in the form of *vestigial single side-band* (VSSB) is used.

The 70-MHz, FM *intermediate frequency* (IF) carrier therefore must be demodulated, and the baseband information used to generate a VSSB signal which is fed into one of the VHF/UHF channels of a standard TV set.

3.4 Master Antenna TV System

A *master antenna TV* (MATV) system is used to provide reception of DBS TV/FM channels to a small group of users, for example, to the tenants in an apartment building. It consists of a single outdoor unit (antenna and LNA/C) feeding a number of indoor units, as shown in Fig.

It is basically similar to the home system already described, but with each user having access to all the channels independently of the other users. The advantage is that only one outdoor unit is required, but as shown, separate LNA/Cs and feeder cables are required for each sense of polarization.

Compared with the single-user system, a larger antenna is also required (2- to 3-m diameter) in order to maintain a good signal-to-noise ratio at all the indoor units.

Where more than a few subscribers are involved, the distribution system used is similar to the *community antenna* (CATV) system described in the following section.

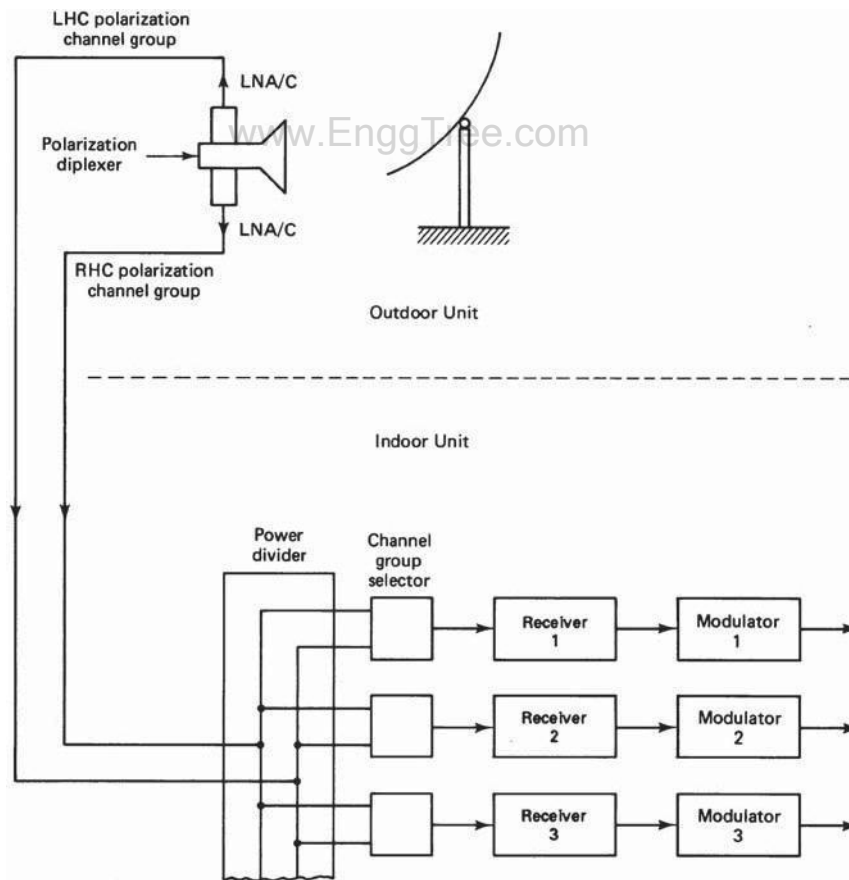

Figure 3.4 CATV System block diagrams

3.5 Community Antenna TV System

The CATV system employs a single outdoor unit, with separate feeds available for each sense of polarization, like the MATV system, so that all channels are made available simultaneously at the indoor receiver.

Instead of having a separate receiver for each user, all the carriers are demodulated in a common receiver-filter system, as shown in Fig. The channels are then combined into a standard multiplexed signal for transmission over cable to the subscribers.

In remote areas where a cable distribution system may not be installed, the signal can be rebroadcast from a low-power VHF TV transmitter.

Figure shows a remote TV station which employs an 8-m (26.2-ft) antenna for reception of the satellite TV signal in the C band.

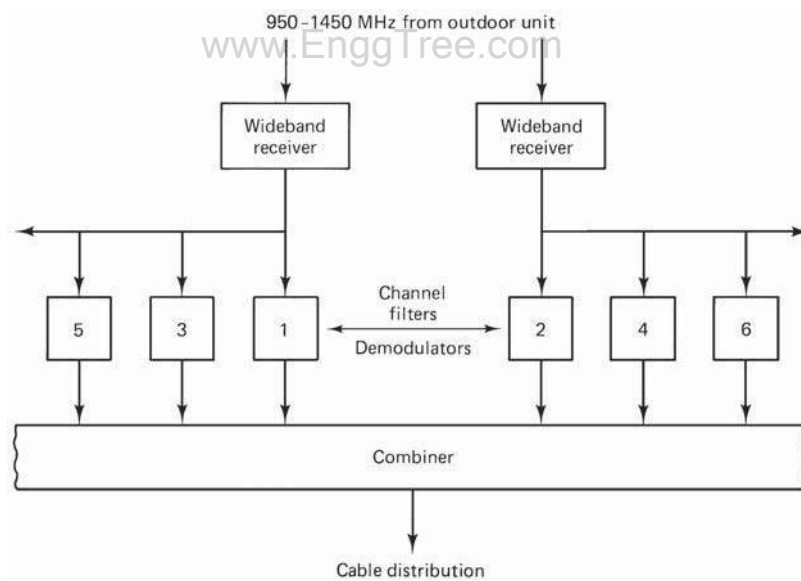

Figure 3.5 One possible arrangement for the indoor unit of a community antenna TV (CATV) system.

With the CATV system, local programming material also may be distributed to subscribers, an option which is not permitted in the MATV system.

3.6 Test Equipment Measurements on G/T, C/No, EIRP

Measurement of G/T of small antennas is easily and simply measured using the spectrum analyser method. For antennas with a diameter of less than 4.5 meters it is not normally necessary to point off from the satellite.

A step in frequency would be required into one of the satellite transponder guard bands.

However antennas with a G/T sufficiently large to enable the station to see the transponder noise floor either a step in frequency into one of the satellite transponder guard bands and/or in azimuth movement would be required.

The test signal can be provided from an SES WORLD SKIES beacon.

Procedure

(a) Set up the test equipment as shown below. Allow half an hour to warm up, and then calibrate in accordance with the manufacturer's procedures.

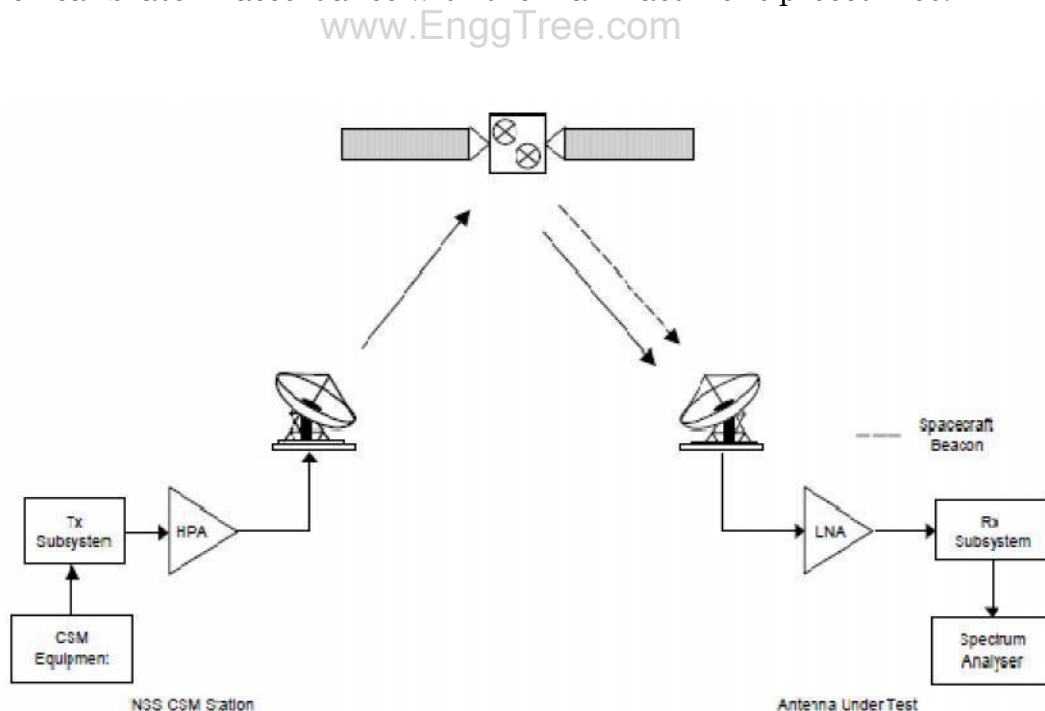

Figure 3.6 One possible arrangement for Measurement of G/T

(b) Adjust the centre frequency of your spectrum analyzer to receive the SES WORLD SKIES beacon (data to be provided on the satellite used for testing)

(c) Carefully peak the antenna pointing and adjust the polarizer by nulling the cross polarized signal. You cannot adjust polarization when using the circularly polarized SES WORLD SKIES beacon.

(d) Configure the spectrum analyser as follows:

Centre Frequency: Adjust for beacon or test signal frequency (to be advised).

Use marker to peak and marker to centre functions.

- Frequency Span: 100 KHz
- Resolution Bandwidth: 1 KHz
- Video Bandwidth: 10 Hz (or sufficiently small to limit noise variance)
- Scale: 5 dB/div
- Sweep Time: Automatic
- Attenuator Adjust to ensure linear operation. Adjust to provide the "Noise floor delta" described in steps 7 and 8.

(e) To insure the best measurement accuracy during the following steps, adjust the spectrum analyser amplitude (reference level) so that the measured signal, carrier or noise, is approximately one division below the top line of the spectrum analyser display.

(f) Record the frequency and frequency offset of the test signal from the nominal frequency:

For example, assume the nominal test frequency is 11750 MHz but the spectrum analyser shows the peak at 11749 MHz. The frequency offset in this case is -1 MHz.

(g) Change the spectrum analyser centre frequency as specified by SES WORLD SKIES so that the measurement is performed in a transponder guard band so that only system noise power of the earth station and no satellite signals are received. Set the spectrum analyser frequency as follows:

Centre Frequency = Noise slot frequency provided by the PMOC

(h) Disconnect the input cable to the spectrum analyser and confirm that the noise floor drops by at least 15 dB but no more than 25dB. This confirms that the spectrum analyser's noise contribution has an insignificant effect on the measurement. An input attenuation value allowing a "Noise floor Delta" in excess of 25 dB may cause overloading of the spectrum analyser input. (i) Reconnect the input cable to the spectrum analyser.

(j) Activate the display line on the spectrum analyser.

(k) Carefully adjust the display line to the noise level shown on the spectrum analyser. Record the display line level.

(l) Adjust the spectrum analyser centre frequency to the test carrier frequency recorded in step (e).

(m) Carefully adjust the display line to the peak level of the test carrier on the spectrum analyser. Record the display line level.

www.EnggTree.com

(n) Determine the difference in reference levels between steps (l) and (j) which is the (C+N)/N.

(o) Change the (C+N)/N to C/N by the following conversion:

This step is not necessary if the (C+N)/N ratio is more than 20 dB because the resulting correction is less than 0.1 dB.

$$\left(\frac{C}{N}\right) = 10 \log_{10} \left(10^{\frac{(C+N)}{N} / 10} - 1 \right) \quad \text{dB}$$

(p) Calculate the carrier to noise power density ratio (C/No) using:

$$\left(\frac{C}{N_0}\right) = \left(\frac{C}{N}\right) - 2.5 + 10 \log_{10}(\text{RBW} \times \text{SA}_{\text{corr}}) \quad \text{dB}$$

The 2.5 dB figure corrects the noise power value measured by the log converters in the spectrum analyser to a true RMS power level, and the SA_{corr}

factor takes into account the actual resolution filter bandwidth. (q) Calculate the G/T using the following:

$$\left(\frac{G}{T}\right) = \left(\frac{C}{N_o}\right) - (EIRP_{SC} - A_{corr}) + (\Gamma_{SL} + L_a) - 228.6 \quad \text{dB/K}$$

where,

EIRP_{SC} – Downlink EIRP measured by the PMOC

(dBW) A_{corr} – Aspect correction supplied by the PMOC

(dB)

FSL – Free Space Loss to the AUT supplied by the PMOC (dB)

L_a – Atmospheric attenuation supplied by the PMOC (dB)

(r) Repeat the measurement several times to check consistency of the result.

3.7 Antenna Gain

Antenna gain is usually **defined** as the ratio of the power produced by the **antenna** from a far-field source on the **antenna's** beam axis to the power produced by a hypothetical lossless isotropic **antenna**, which is equally sensitive to signals from all directions.

www.EnggTree.com

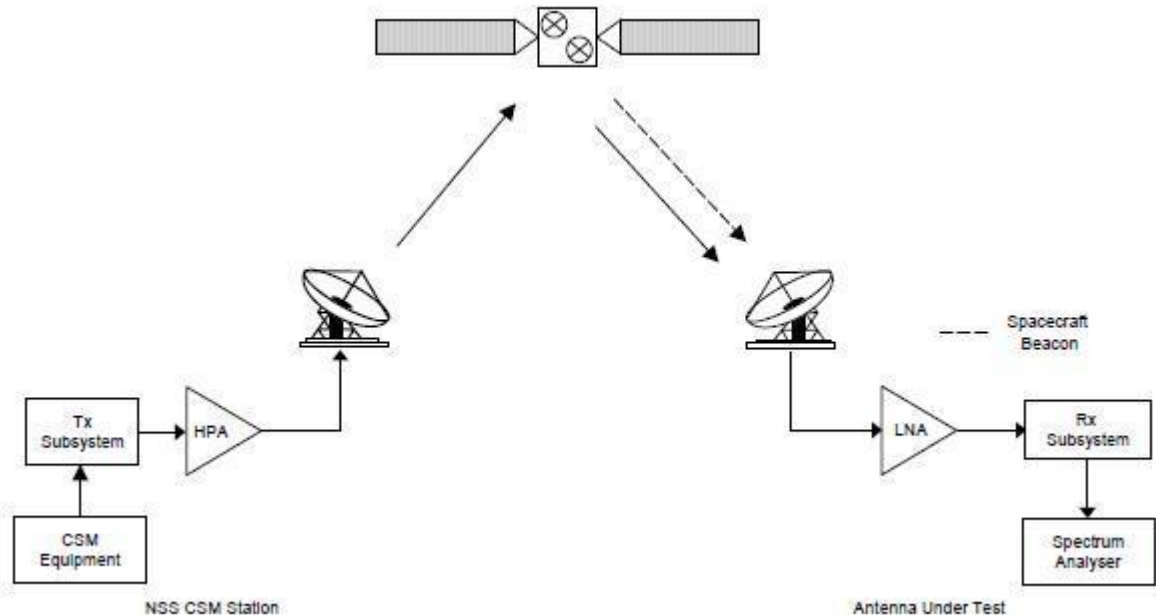

Figure 3.6 One possible arrangement for Measurement of Antenna Gain

Two direct methods of measuring the Rx gain can be used; integration of the Rx sidelobe pattern or by determination of the 3dB and 10dB beamwidths.

The use of pattern integration will produce the more accurate results but would require the AUT to have a tracking system. In both cases the test configurations for measuring Rx gain are identical, and are illustrated in Figure.

In order to measure the Rx gain using pattern integration the AUT measures the elevation and azimuth narrowband ($\pm 5^\circ$ corrected) sidelobe patterns.

The AUT then calculates the directive gain of the antenna through integration of the sidelobe patterns. The Rx gain is then determined by reducing the directive gain by the antenna inefficiencies.

In order to measure the Rx gain using the beamwidth method, the AUT measures the corrected azimuth and elevation 3dB/10dB beamwidths. From these results the Rx gain of the antenna can be directly calculated using the formula below.

$$G = 10 \log_{10} \left[\frac{1}{2} \left(\frac{31000}{(Az_3)(El_3)} + \frac{91000}{(Az_{10})(El_{10})} \right) \right] - F_{Loss} - R_{Loss}$$

where:

- G is the effective antenna gain (dBi)
- Az3 is the corrected azimuth 3dB beamwidth ($^\circ$)
- El3 is the elevation 3dB beamwidth ($^\circ$)
- Az10 is the corrected azimuth 10dB beamwidth ($^\circ$)
- El10 is the elevation 10dB beamwidth ($^\circ$)
- F_{Loss} is the insertion loss of the feed (dB)

R_{Loss} is the reduction in antenna gain due to reflector inaccuracies, and is given by:

$$R_{Loss} = 4.922998677(Sdev f)^2 \text{ dB}$$

where: Sdev is the standard deviation of the actual reflector surface (inches)
f is the frequency (GHz)

APPLICATIONS

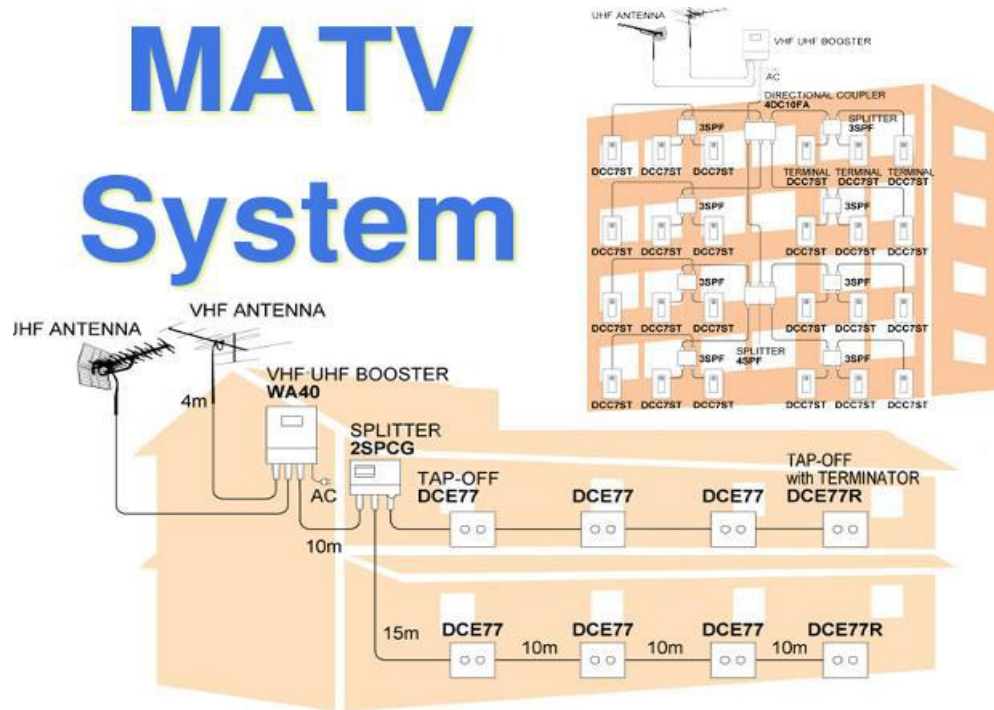

Figure an example of MATV system

www.EnggTree.com

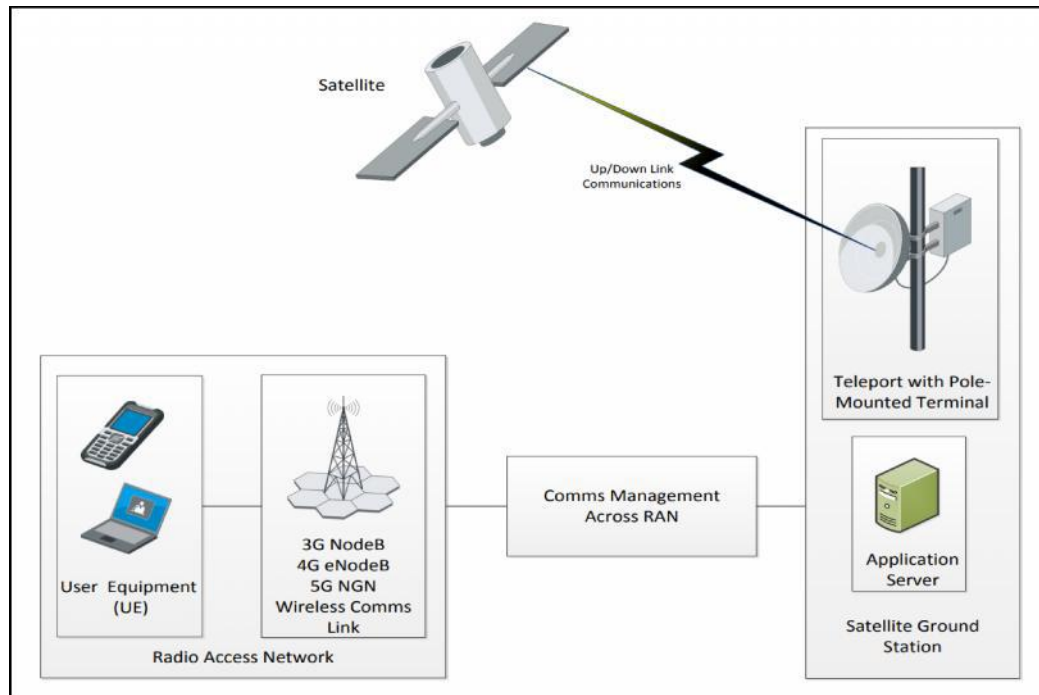

Figure an example of Satellite Earth Station

POST TEST MCQ

1. The earth segment of a satellite communications system consists of _____.
 - a) **The earth segment of a satellite communications system consists of the transmit and receive earth stations**
 - b) With active attitude control, there is no overall stabilizing torque present to resist the disturbance torques
 - c) Proper moment
 - d) None of these

2. In the Americas, for example, the down-link band is _____.
 - a) **12.2 to 12.7 GHz**
 - b) With active attitude control, there is no overall stabilizing torque present to resist the disturbance torques
 - c) The Ku (12-GHz) band
 - d) 64-GHz to 164 GHz

3. The major difference between the Ku-band and the C-band that satellites intended for DBS have much _____.
 - a) Low noise
 - b) The indoor unit
 - c) The home unit
 - d) **higher equivalent isotropic radiated power(EIRP)**

4. MATV stand as _____.
 - a) Multi amplitude TV
 - b) Maximum Angular TV
 - c) **Master antenna TV**
 - d) Multiplex All TV

5. The orbital spacing is _____ for the high-power satellites, so adjacent satellite interference is considered nonexistent.
 - a) 18°
 - b) **9°**
 - c) 27°.
 - d) 45°

6. A satellite may carry _____ transponders

- a) **32**
- b) 41
- c) 24
- d) 64

7. The frequencies for direct broadcast satellites vary from region to region throughout the world, although these are generally in the _____

- a) **Ku band**
- b) Ka band
- c) C band
- d) W band

8. A master antenna TV (MATV) system is used to provide reception of DBS TV/FM channels to a small group of users, for example _____

- a) **To the tenants in an apartment building**
- b) With attitude control, there is no overall stabilizing torque present to resist the disturbance torques
- c) The Ku (12-GHz) band
- d) None of these

9. A master antenna TV (MATV) system is used to provide reception of _____ to a small group of users, for example to the tenants in an apartment building.

- a) **DBS TV/FM channels**
- b) FM channels
- c) The Ku (12-GHz) band
- d) None of these

10. CATV stands as _____

- a) **Community antenna TV**
- b) Carrier angular TV
- c) Cost amplitude TV
- d) Cost angular TV

11. The CATV system employs a single _____ with separate feeds available for each sense of polarization.

a) Outdoor unit

b) Indoor unit

c) TV unit

d) Input unit

12. With the CATV system, local programming material also may be distributed to subscribers, an option which is _____ in the MATV system.

a) Not permitted

b) Permitted

c) Transmitted

d) None of these

13. Out of the following, find what is an polar antenna.

a) A single actuator is used which moves the antenna in a circular arc ie known as polar mount antenna.

b) An double actuator is used which moves the antenna in a circular arc ie known as polar mount antenna.

c) A single actuator is used which moves the antenna in a elliptical arc ie known as polar mount antenna.

d) None of above

14. Definition of a transponder is

a) In a communication satellite, the equipment which provides the connecting link between the satellite's transmit & receive antennas is referred to as the transponder.

b) In a communication satellite, the equipment which provides the power supply is referred to as the transponder

c) a & b

d) None of above

15. Definition of spot beam antenna is

a) **A beam generated by a communication satellite antenna of sufficient size that the angular spread of sufficient size that the angular spread of the energy in the beam is very small with the result that a region that is only a few hundred km in diameter is illuminated on earth.**

b) A beam generated by a communication satellite antenna of sufficient size that the angular spread of sufficient size that the angular spread of the energy in the beam is very slarge with the result that a region that is only a few hundred mm in diameter is illuminated on earth.

c) Either a or b.

d) None of above

16. Definition of an EIRP is

a) It is a measure of radiated or transmitted power of an antenna. It can be completed from the antenna gain & the power fed from the antenna output.

b) It is a measure of radiated or transmitted power of an antenna. It can be completed from the antenna gain & the power fed to the antenna input.

c) Either a or b

d) None of above

17. **Antenna losses is defined as**

a) It is add to noise received as radiation is in the sum of the equivalent noise temperature of all these sources.

b) It is add to noise received as radiation & the total antenna noise temperature is in the divider of the equivalent noise temperature of all these sources.

c) It is add to noise received as radiation & the total antenna noise temperature is in the sum of the equivalent noise temperature of all these sources.

d) None of above

18. Satellite launch sites are invariably located on Eastern seaboard to ensure that

- a) launch takes place eastward
- b) expenditure of propulsion fuel is reduced during plane changing
- c) the satellite achieves circular orbit quickly
- d) spent rocket motor and other launcher debris falls into the sea**

19. Of the four INSAT-I satellites planned by India so far, only _____ has proved to be successful.

- a) INSAT-IA
- b) INSAT-IB**
- c) INSAT-IC
- d) INSAT-ID

20. India's first domestic geostationary satellite INSAT-1A was launched on 10th April 1982 from

- a) USSR
- b) USA**
- c) UK
- d) Ukraine

www.EnggTree.com

21. A transponder is a satellite equipment which

- a) receives a signal from Earth station and amplifies
- b) changes the frequency of the received signal
- c) retransmits the received signal
- d) does all of the above-mentioned functions**

CONCLUSION

- ❖ In this unit we described the earth segment and space segment.
- ❖ The Outdoor UNIT – Indoor UNIT for analog (FM) TV were elaborated.
- ❖ The Equipment Measurements on G/T, C/N, EIRP was discussed.

REFERENCES

1. Wilbur L.Pritchard, Hendri G. Suyderhoud, Robert A. Nelson, “Satellite Communication Systems Engineering”, Prentice Hall/Pearson, 2007.
2. N. Agarwal, “Design of Geosynchronous Space Craft”, Prentice Hall, 1986.
3. Bruce R. Elbert, “Satellite Communication Applications”, Hand Book, Artech House Bostan London,1997.
4. Tri T. Ha, “Digital Satellite Communication”, II nd edition, 1990.
5. Robert G. Winch, “Telecommunication Transmission Systems”, Mc Graw-Hill Book Co., 1983.
6. Brian Ackroyd, “World Satellite Communication and earth station Design”, BSP professional Books, 1990.
7. G.B.Bleazard, “Introducing Satellite communications“, NCC Publication, 1985.
8. M.Richharia, “Satellite Communication Systems-Design Principles”, Macmillan 2003.
9. Emanuel Fthenakis, “Manual of Satellite Communications”, Mc Graw Hill Book Co., 1984.

ASSIGNMENT

1. What is Cassegrain antenna popular for large earth stations?
2. Why is G/T ratio a useful parameter to characterize earth stations?
3. Explain the major test equipments required at an earth station?
4. Write short notes on Community antenna TV system?
5. Write the short notes on TVRO system?
6. Explain about the feeder losses and antenna misalignment losses?
7. Derive link power budget equation.

SATELLITE COMMUNICATION

www.EnggTree.com

UNIT IV SATELLITE ACCESS

UNIT IV SATELLITE ACCESS

AIM & OBJECTIVE

- ❖ To understand the basics of Modulation and Multiplexing
- ❖ To analyze the Assignment Methods.
- ❖ To understand the Spread Spectrum communication.

PRE TEST MCQ

1. In satellite communication modulation is used.
 - a) AM
 - b) FM**
 - c) PWM
 - d) PAM

2. In TV broadcast via satellite the TV signal from the main broadcast station is routed to the earth station via www.EnggTree.com
 - a) Low power transmitter
 - b) Microwave links
 - c) TV relay stations
 - d) Microwave repeater stations**

3. The main advantage of satellite communication is
 - a) Low cost
 - b) Low distortion
 - c) High reliability**
 - d) High band width

4.1 Modulation and Multiplexing: Voice, Data, Video

Communications satellites are used to carry telephone, video, and data signals, and can use both analog and digital modulation techniques.

Modulation

Modification of a carrier's parameters (amplitude, frequency, phase, or a combination of them) in dependence on the symbol to be sent.

Multiplexing

Task of multiplexing is to assign space, time, frequency, and code to each communication channel with a minimum of interference and a maximum of medium utilization. Communication channel refers to an association of sender(s) and receiver(s) that want to exchange data. One of several constellations of a carrier's parameters defined by the used modulation scheme.

4.1.1 Voice, Data, Video

The modulation and multiplexing techniques that were used at this time were analog, adapted from the technology developed for The change to digital voice signals made it easier for long-distance.

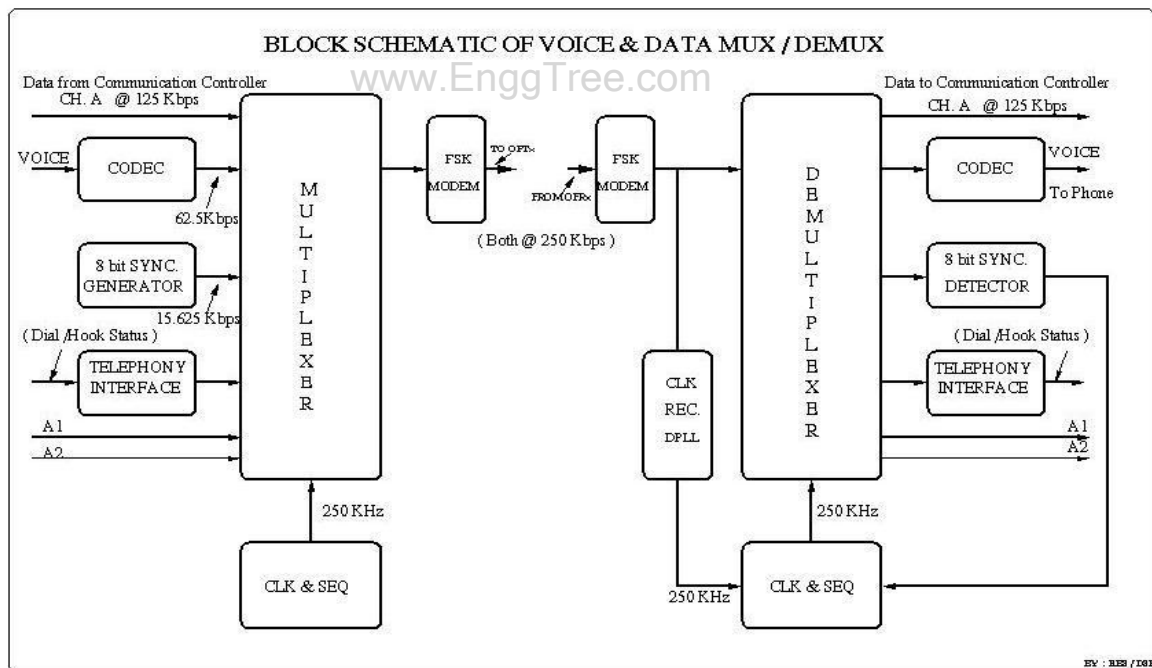

Figure 4.1 Modulation and Multiplexing: Voice/Data/Video

Communication carriers to mix digital data and telephone Fiber-optic Cable Transmission Standards System Bit rate (Mbps) 64 - kbps Voice channel capacity Stuffing bits and words are added to the satellite data stream as needed to fill empty bit and word spaces.

Primarily for video provided that a satellite link's overall carrier-to-noise but in to older receiving equipment at System and Satellite Specification Ku - band satellite parameters.

4.1.2 Modulation And Multiplexing

In analog television (TV) transmission by satellite, the baseband video signal and one or two audio subcarriers constitute a composite video signal.

Digital modulation is obviously the modulation of choice for transmitting digital data are digitized analog signals may conveniently share a channel with digital data, allowing a link to carry a varying mix of voice and data traffic.

Digital signals from different channels are interleaved for transmission through time division multiplexing TDM carry any type of traffic " the bent pipe transponder that can carry voice, video, or data as the marketplace demands.

Hybrid multiple access schemes can use time division multiplexing of baseband channels which are then modulate.

4.2 Analog – digital transmission system

4.2.1 Analog vs. Digital Transmission

Compare at two levels:

1. Data—continuous (audio) vs. discrete (text)
2. Signaling—continuously varying electromagnetic wave vs. sequence of voltage pulses.

Also Transmission—transmit without regard to signal content vs. being concerned with signal content. Difference in how attenuation is handled, but not focus on this. Seeing a shift towards digital transmission despite large analog base. Why?

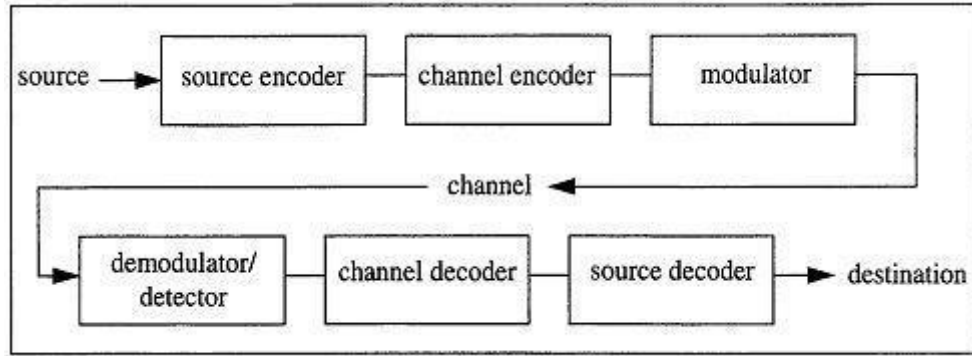

Figure 4.2 basic communication systems

- Improving digital technology
- Data integrity. Repeaters take out cumulative problems in transmission. Can thus transmit longer distances.
- Easier to multiplex large channel capacities with digital
- Easy to apply encryption to digital data
- Better integration if all signals are in one form. Can integrate voice, video and digital data.

4.2.2 Digital Data/Analog Signals

Must convert digital data to analog signal such device is a modem to translate between bit-serial and modulated carrier signals?

To send digital data using analog technology, the sender generates a carrier signal at some continuous tone (e.g. 1-2 kHz in phone circuits) that looks like a sine wave. The following techniques are used to encode digital data into analog signals.

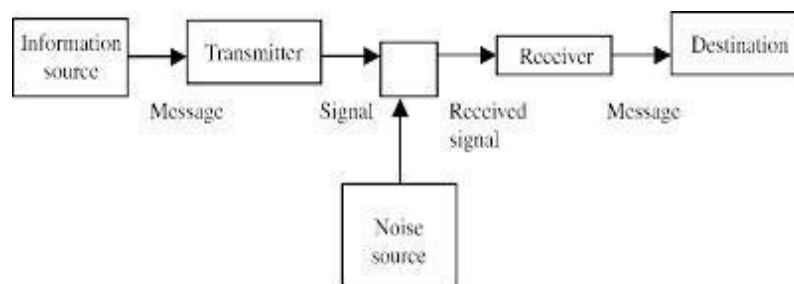

Figure 4.3 Digital /Analog Transmitter & receiver

Resulting bandwidth is centered on the carrier frequency.

- Amplitude-shift modulation (keying): vary the amplitude (e.g. voltage) of the signal. Used to transmit digital data over optical fiber.
- Frequency-shift modulation: two (or more tones) are used, which are near the carrier frequency. Used in a full-duplex modem (signals in both directions).
- Phase-shift modulation: systematically shift the carrier wave at uniformly spaced intervals.

For instance, the wave could be shifted by 45, 135, 225, 315 degree at each timing mark. In this case, each timing interval carries 2 bits of information.

Why not shift by 0, 90, 180, 270? Shifting zero degrees means no shift, and an extended set of no shifts leads to clock synchronization difficulties.

Frequency division multiplexing (FDM): Divide the frequency spectrum into smaller subchannels, giving each user exclusive use of a subchannel (e.g., radio and TV). One problem with FDM is that a user is given all of the frequency to use, and if the user has no data to send, bandwidth is wasted — it cannot be used by another user.

Time division multiplexing (TDM): Use time slicing to give each user the full bandwidth, but for only a fraction of a second at a time (analogous to time sharing in operating systems). Again, if the user doesn't have data to send during his time slice, the bandwidth is not used (e.g., wasted).

Statistical multiplexing: Allocate bandwidth to arriving packets on demand. This leads to the most efficient use of channel bandwidth because it only carries useful data. That is, channel bandwidth is allocated to packets that are waiting for transmission, and a user generating no packets doesn't use any of the channel resources.

4.3. Digital Video Broadcasting (DVB)

- Digital Video Broadcasting (DVB) has become the synonym for digital television and for data broadcasting world-wide.
- DVB services have recently been introduced in Europe, in North- and South America, in Asia, Africa and Australia.

- This article aims at describing what DVB is all about and at introducing some of the technical background of a technology that makes possible the broadcasting.

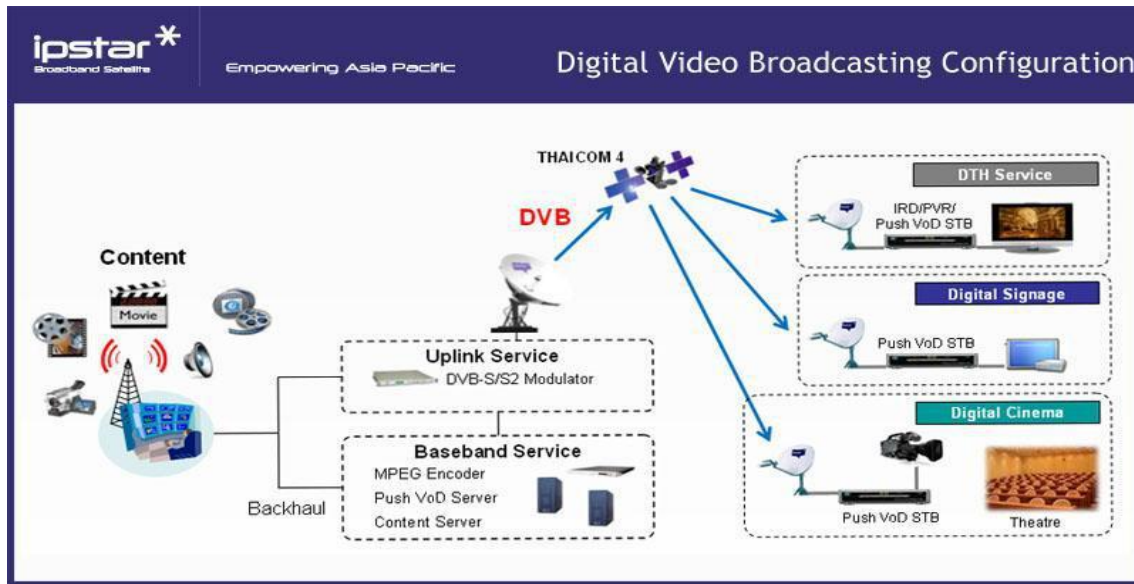

Figure 4.4 Digital Video Broadcasting systems

4.4 Multiple Access Techniques

- ❖ The transmission from the BS in the downlink can be heard by each and every mobile user in the cell, and is referred as *broadcasting*. Transmission from the mobile users in the uplink to the BS is many-to-one, and is referred to as multiple access.
- ❖ Multiple access schemes to allow many users to share simultaneously a finite amount of radio spectrum resources.
 - Should not result in severe degradation in the performance of the system as compared to a single user scenario.
 - Approaches can be broadly grouped into two categories: narrowband and wideband.
- ❖ Multiple Accessing Techniques : with possible conflict and conflict - free

- Random access
- Frequency division multiple access (FDMA)
- Time division multiple access (TDMA)
- Spread spectrum multiple access (SSMA) : an example is Code division multiple access (CDMA)
- Space division multiple access (SDMA)

Duplexing

For voice or data communications, must assure two way communication (duplexing, it is possible to talk and listen simultaneously). Duplexing may be done using frequency or time domain techniques.

- ❖ Forward (downlink) band provides traffic from the BS to the mobile
- ❖ Reverse (uplink) band provides traffic from the mobile to the BS.

4.4.1 Frequency division duplexing (FDD)

Provides two distinct bands of frequencies for every user, one for downlink and one for uplink. www.EnggTree.com

A large interval between these frequency bands must be allowed so that interference is minimized.

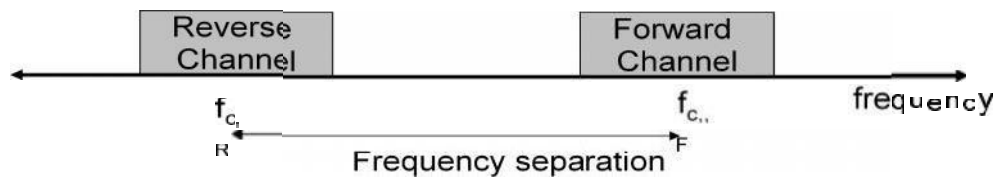

Frequency separation should be carefully decided
Frequency separation is constant

Figure 4.5 Frequency Separation

4.4.2. Time division duplexing (TDD)

- ❖ In TDD communications, both directions of transmission use one contiguous frequency allocation, but two separate time slots to provide both a forward and reverse link.

- ❖ Because transmission from mobile to BS and from BS to mobile alternates in time, this scheme is also known as “ping pong”.
- ❖ As a consequence of the use of the same frequency band, the communication quality in both directions is the same. This is different from FDD.

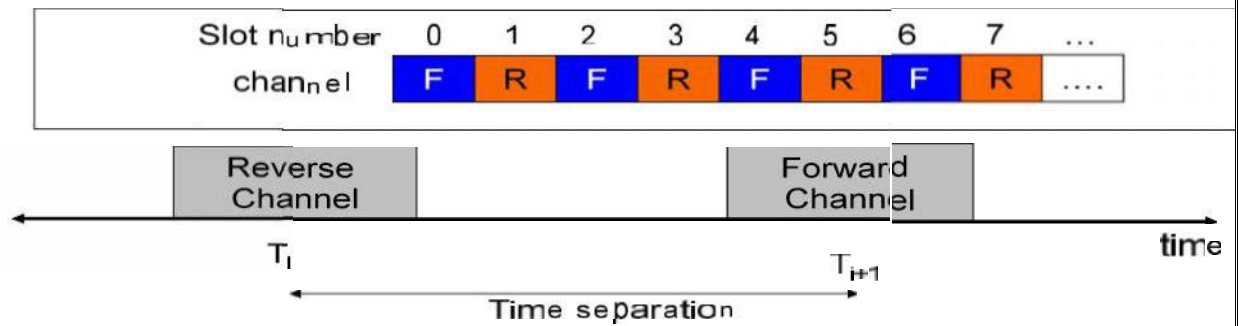

Figure 4.6 Time Slot

4.4.3 FDMA

- ❖ In FDMA, each user is allocated a unique frequency band or channel. During the period of the call, no other user can share the same frequency band.

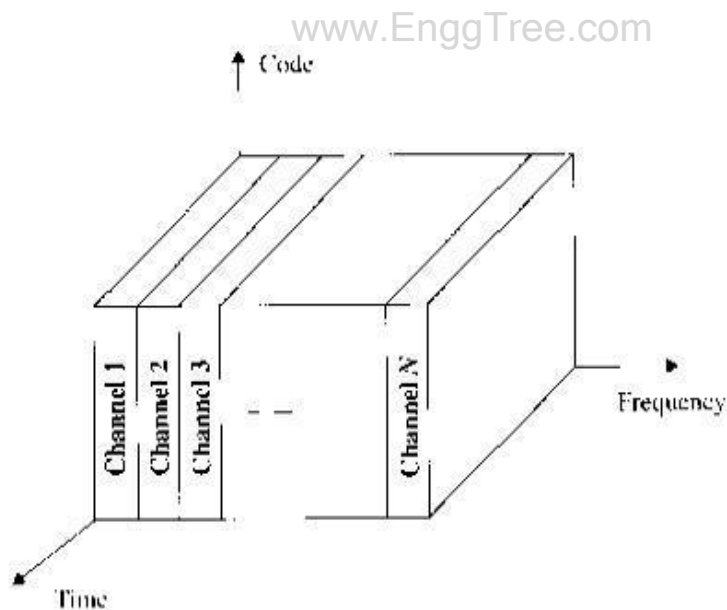
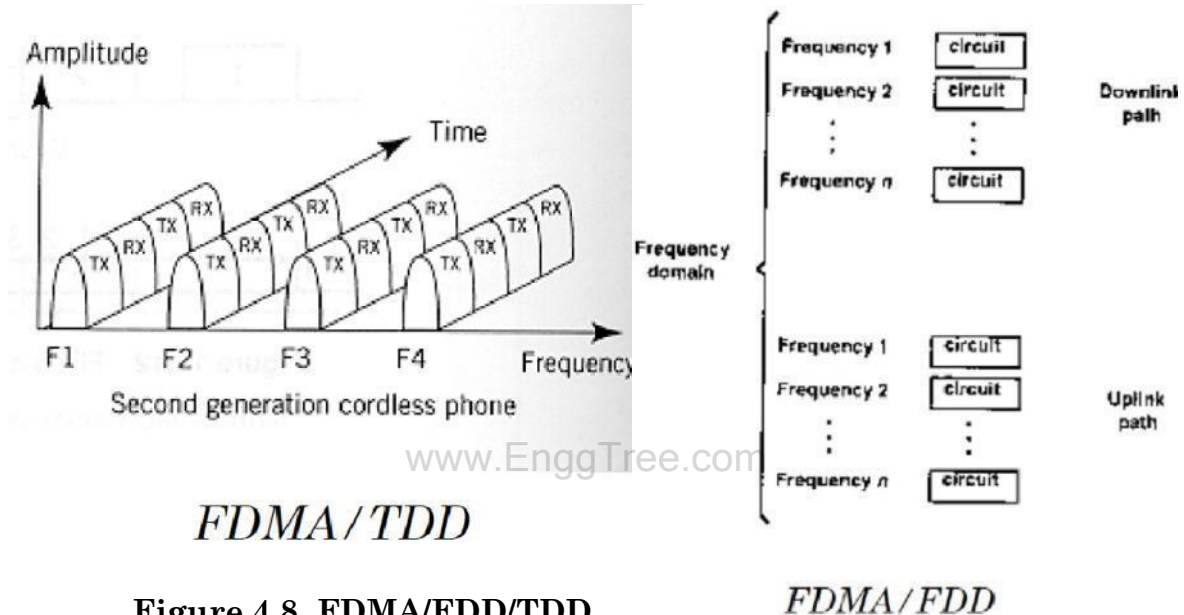

Figure 4.7 FDMA Channels

- ❖ All channels in a cell are available to all the mobiles. Channel assignment is carried out on a first-come first- served basis.

- ❖ The number of channels, given a frequency spectrum BT , depends on the modulation technique (hence Bw or Bc) and the guard bands between the channels $2B_{guard}$.
- ❖ These guard bands allow for imperfect filters and oscillators and can be used to minimize adjacent channel interference.
- ❖ FDMA is usually implemented in narrowband systems.



Nonlinear effects in FDMA

- In a FD MA system, many channels share t he same antenna at the BS. The power amplifiers or the power combiners, when operated at or near saturation are non linear.
- The nonlinear ties generate inter-modulation frequencies.
- Undesirable harmonics generated outside the mobile radio band cause interference to adjacent services.
- Undesirable harmonics present inside the band ca use interference to other users in the mobile system.

4.4.4 TDMA

- TDMA systems divide the channel time into frames. Each frame is further partitioned into time slots. In each slot only one user is allowed to either transmit or receive.
- Unlike FDMA, only digital data and digital modulation must be used.
- Each user occupies a cyclically repeating time slot, so a channel may be thought of as a particular time slot of every frame, where N time slots comprise a frame.

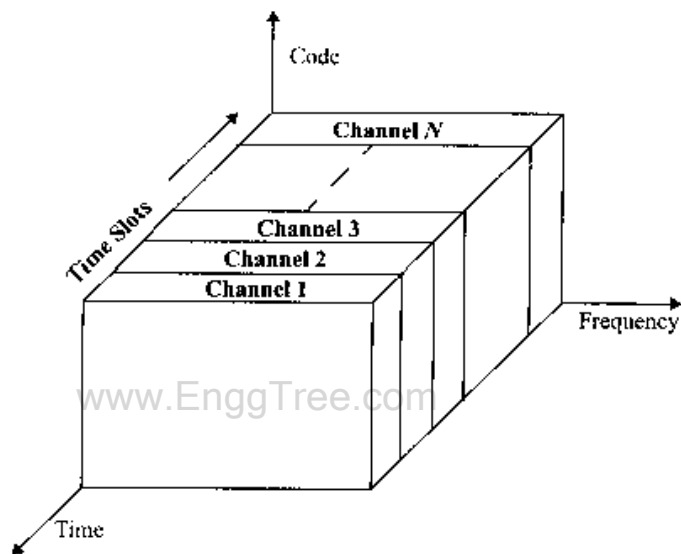
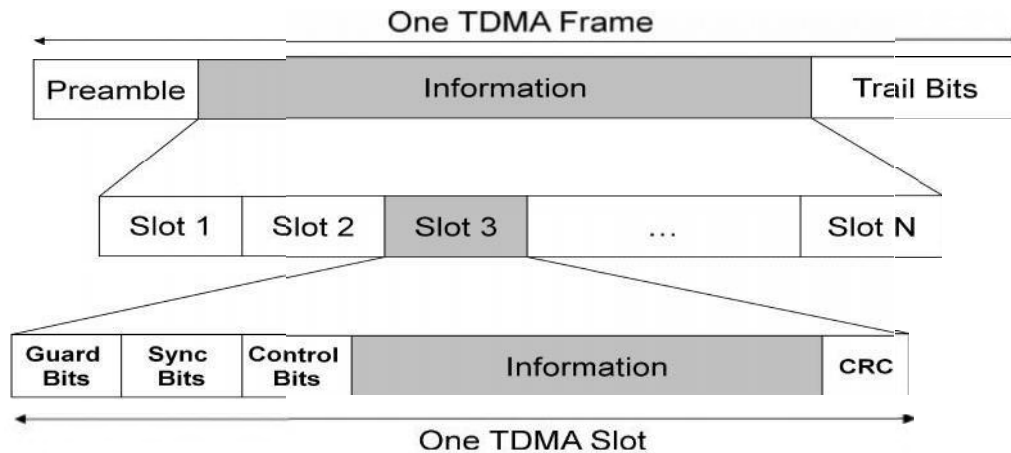

Figure 4.9 TDMA Channels

Features

- ❖ Multiple channels per carrier or RF channels.
- ❖ Burst transmission since channels are used on a timesharing basis.
 - Transmitter can be turned off during idle periods.
- ❖ Narrow or wide bandwidth – depends on factors such as modulation scheme, number of voice channels per carrier channel.
- ❖ High ISI – Higher transmission symbol rate, hence resulting in high ISI.
 - Adaptive equalizer required.



A Frame repeats in time

Figure 3.10 TDMA Channels time slot

- ❖ A guard time between the two time slots must be allowed in order to avoid
 - interference, especially in the uplink direction.
 - ❖ mobiles should All synchronize with BS to minimize interference.
- ❖ Efficient power utilization : FDMA systems require a 3- to 6-dB power back off in order to compensate for inter-modulation effects.
- ❖ Efficient handoff : TDMA systems can take advantage of the fact that the transmitter is switched off during idle time slots to improve the handoff procedure. An enhanced link control, such as that provided by mobile assisted handoff (MAHO) can be carried out by a subscriber by listening to
 - neighboring base station during the idle slot of the TDMA frame.
- ❖ Efficiency of TDMA
- ❖ Efficiency of TDMA is a measure of the percentage of bits per frame which contain transmitted data. The transmitted data include source and channel coding bits.

$$\bullet \quad \eta_f = \frac{b_T - b_{OH}}{b_T} \cdot 100\%$$

- ❖ b_{OH} includes all overhead bits such as preamble, guard bits, etc.

4.4.5 Code Division Multiple Access (CDMA)

- ❖ Spreading signal (code) consists of chips
 - Has Chip period and hence, chip rate
 - Spreading signal use a pseudo-noise (PN) sequence (a pseudo-random sequence)
 - PN sequence is called a codeword
 - Each user has its own cordword
 - Codewords are orthogonal. (low autocorrelation)
 - Chip rate is order of magnitude larger than the symbol rate.
- ❖ The receiver correlator distinguishes the senders signal by examining the wideband signal with the same time-synchronized spreading code
- ❖ The sent signal is recovered by despreading process at the receiver.

CDMA Advantages: www.EnggTree.com

- ❖ Low power spectral density.
 - Signal is spread over a larger frequency band
 - Other systems suffer less from the transmitter
- ❖ Interference limited operation
 - All frequency spectrum is used
- ❖ Privacy
 - The codeword is known only between the sender and receiver. Hence other users can not decode the messages that are in transit
- ❖ Reduction of multipath affects by using a larger spectrum

CDMA data

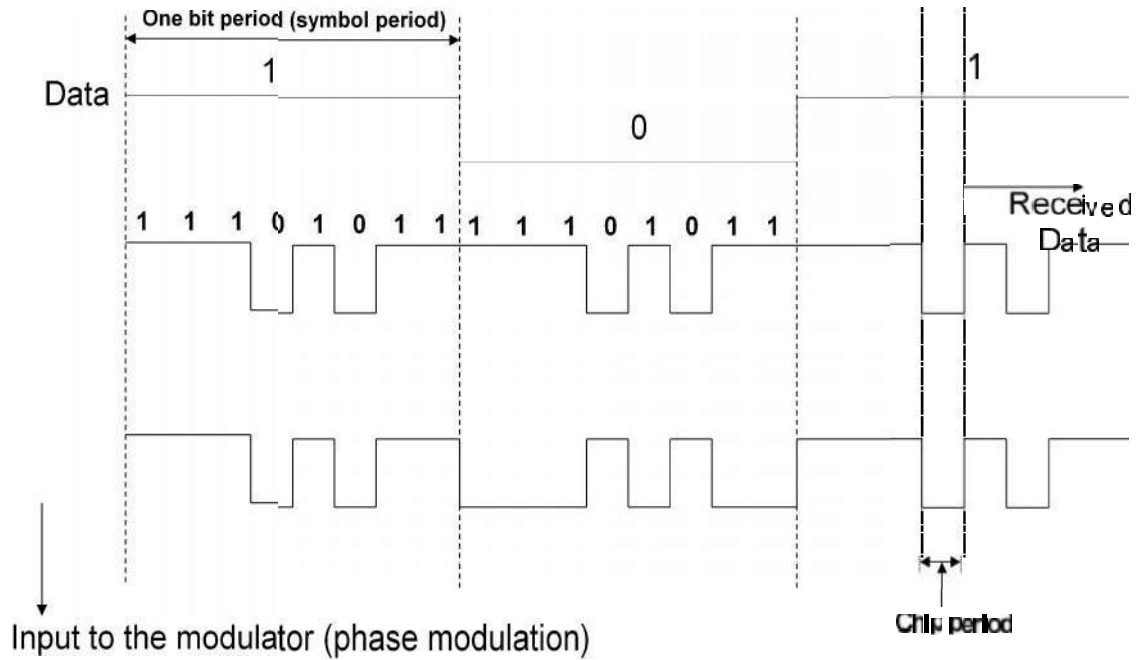

Figure 4.11 CDMA Channels transmission

www.EnggTree.com

DSSS Transmitter:

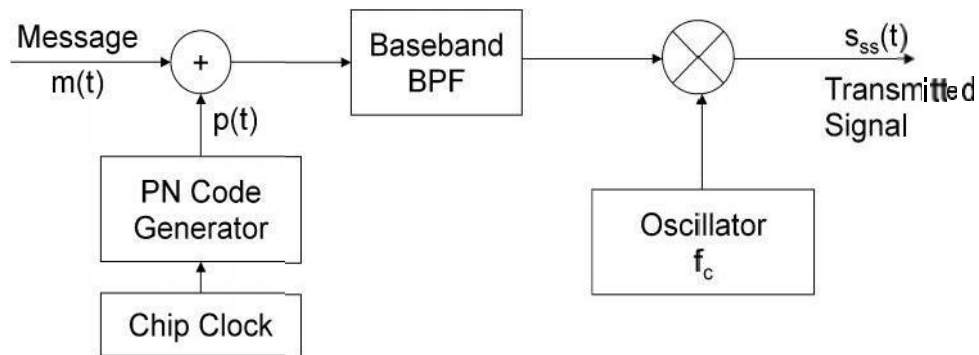
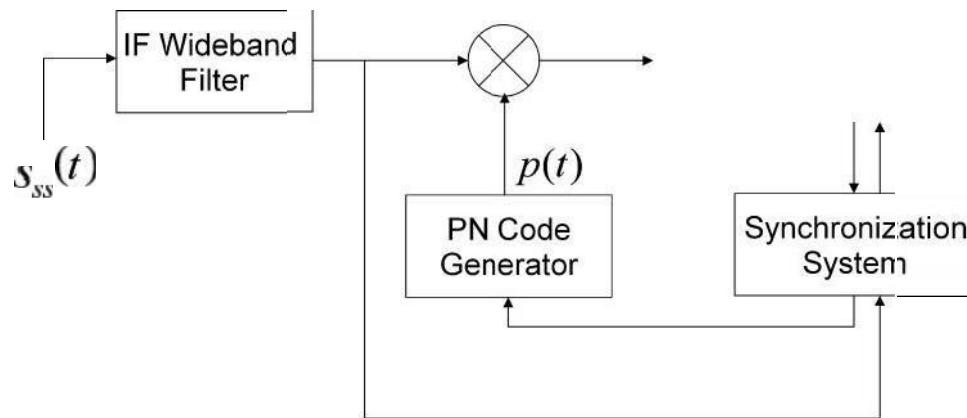

Figure 4.12 CDMA Transmitter

$$s_{ss}(t) = \sqrt{\frac{2E_s}{T_s}} m(t) p(t) \cos(2\pi f_c t + \theta)$$

DSSS Receiver



$$s_1(t) = \sqrt{\frac{2E_s}{T_s}} m(t) \cos(2\pi f_c t + \theta)$$

Figure 4.13 CDMA Receiver

❖ FDMA/CDMA

www.EnggTree.com

- Available wideband spectrum is frequency divided into number narrowband radio channels. CDMA is employed inside each channel.

❖ DS/FHMA

- The signals are spread using spreading codes (direct sequence signals
- are obtained), but these signal are not transmitted over a constant
- carrier frequency; they are transmitted over a frequency hopping carrier frequency.

❖ Time Division CDMA (TCDMA)

Each cell is using a different spreading code (CDMA employed between cells) that is conveyed to the mobiles in its range.

Inside each cell (inside a CDMA channel), TDMA is employed to multiplex multiple users.

❖ Time Division Frequency Hopping

At each time slot, the user is hopped to a new frequency according to a pseudo-random hopping sequence.

Employed in severe co-interference and multi-path environments.

Bluetooth and GSM are using this technique

- ❖ A large number of independently steered high-gain beams can be formed without any resulting degradation in SNR ratio.
- ❖ Beams can be assigned to individual users, thereby assuring that all links operate with maximum gain.
- ❖ Adaptive beam forming can be easily implemented to improve the system capacity by suppressing co channel interference.

Advantage of CDMA

- ❖ It is recognized that CDMA's capacity gains over TDMA
- ❖ FDMA are entirely due to Its tighter, dynamic control over the use of the power domain. www.EnggTree.com
- ❖ Choosing a new non-orthogonal PN sequence a CDMA system does not encounter the difficulties of choosing a spare carrier frequency or time slot to carry a Traffic Channel
- ❖ Ensure that interference will not be too great if it begins to transmit -that there is still enough space left in the power domain.

Disadvantages of CDMA

- ❖ Satellite transponders are channelized too narrowly for roadband CDMA, which is the most attractive form of CDMA.
- ❖ Power control cannot be as tight as it is in a terrestrial system because of long round-trip delay.

4.5. Channel allocation schemes

In radio resource management for wireless and cellular network, channel allocation schemes are required to allocate bandwidth and communication channels to base stations, access points and terminal equipment.

The objective is to achieve maximum system spectral efficiency in bit/s/Hz/site by means of frequency reuse, but still assure a certain grade of service by avoiding co-channel interference and adjacent channel interference among nearby cells or networks that share the bandwidth. There are two types of strategies that are followed:-

- ❖ Fixed: FCA, fixed channel allocation: Manually assigned by the network operator
- ❖ Dynamic:
 - DCA, dynamic channel allocation,
 - DFS, dynamic frequency selection
 - Spread spectrum

4.5.1 FCA

In **Fixed Channel Allocation** or **Fixed Channel Assignment** (FCA) each cell is given a predetermined set of frequency channels.

FCA requires manual frequency planning, which is an arduous task in TDMA and FDMA based systems, since such systems are highly sensitive to co-channel interference from nearby cells that are reusing the same channel.

This results in traffic congestion and some calls being lost when traffic gets heavy in some cells, and idle capacity in other cells.

4.5.2. DCA and DFS

Dynamic Frequency Selection (DFS) may be applied in wireless networks with several adjacent non-centrally controlled access points.

A more efficient way of channel allocation would be **Dynamic Channel Allocation** or **Dynamic Channel Assignment** (DCA) in which voice channel are not allocated to cell permanently, instead for every call request base station request channel from MSC.

4.6 Spread spectrum

Spread spectrum can be considered as an alternative to complex DCA algorithms. Spread spectrum avoids cochannel interference between adjacent

cells, since the probability that users in nearby cells use the same spreading code is insignificant.

Thus the frequency channel allocation problem is relaxed in cellular networks based on a combination of Spread spectrum and FDMA, for example IS95 and 3G systems.

In packet based data communication services, the communication is bursty and the traffic load rapidly changing. For high system spectrum efficiency, DCA should be performed on a packet-by-packet basis.

Examples of algorithms for packet-by-packet DCA are **Dynamic Packet Assignment** (DPA), Dynamic Single Frequency Networks (DSFN) and **Packet and resource plan scheduling** (PARPS).

4.6.1 Spread spectrum Techniques

1 In telecommunication and radio communication, spread-spectrum techniques are methods by which a signal (e.g. an electrical, electromagnetic, or acoustic signal) generated with a particular bandwidth is deliberately spread in the frequency domain, resulting in a signal with a wider bandwidth.

2 These techniques are used for a variety of reasons, including the establishment of secure communications, increasing resistance to natural interference, noise and jamming, to prevent detection, and to limit power flux density (e.g. in satellite downlinks).

3 Spread-spectrum telecommunications this is a technique in which a telecommunication signal is transmitted on a bandwidth considerably larger than the frequency content of the original information.

4 Spread-spectrum telecommunications is a signal structuring technique that employs direct sequence, frequency hopping, or a hybrid of these, which can be used for multiple access and/or multiple functions.

5 Frequency-hopping spread spectrum (FHSS), direct-sequence spread spectrum (DSSS), time-hopping spread spectrum (THSS), chirp spread spectrum (CSS).

6 Techniques known since the 1940s and used in military communication systems since the 1950s "spread" a radio signal over a wide frequency range several magnitudes higher than minimum requirement.

7 Resistance to jamming (interference). DS (direct sequence) is good at resisting continuous-time narrowband jamming, while FH (frequency hopping) is better at resisting pulse jamming.

8 Resistance to fading. The high bandwidth occupied by spread- spectrum signals offer some frequency diversity, i.e. it is unlikely that the

signal will encounter severe multipath fading over its whole bandwidth, and in other cases the signal can be detected using e.g. a Rake receiver.

9 Multiple access capability, known as code-division multiple access (CDMA) or code-division multiplexing (CDM). Multiple users can transmit simultaneously in the same frequency band as long as they use different spreading codes.

4.7 Compression – Encryption

At the broadcast center, the high-quality digital stream of video goes through an MPEG encoder, which converts the programming to MPEG-4 video of the correct size and format for the satellite receiver in your house.

Encoding works in conjunction with compression to analyze each video frame and eliminate redundant or irrelevant data and extrapolate information from other frames. This process reduces the overall size of the file. Each frame can be encoded in one of three ways:

- As an **intraframe**, which contains the complete image data for that frame. This method provides the least compression.
- As a **predicted** frame, which contains just enough information to tell the satellite receiver how to display the frame based on the most recently displayed intraframe or predicted frame.
- ❖ As a **bidirectional** frame, which displays information from the surrounding intraframe or predicted frames. Using data from the closest surrounding frames, the receiver **interpolates** the position and color of each pixel.

This process occasionally produces **artifacts** – glitches in the video image. One artifact is **macroblocking**, in which the fluid picture temporarily dissolves into blocks. Macroblocking is often mistakenly called **pixilating**, a technically incorrect term which has been accepted as slang for this annoying artifact.

There really are pixels on your TV screen, but they're too small for your human eye to perceive them individually -- they're tiny squares of video data that make up the image you see. (For more information about pixels and perception, see How TV Works.)

The rate of compression depends on the nature of the programming. If the encoder is converting a newscast, it can use a lot more predicted frames because most of the scene stays the same from one frame to the next.

In more fast-paced programming, things change very quickly from one frame to the next, so the encoder has to create more intraframes. As a result, a newscast generally compresses to a smaller size than something like a car race.

4.7.1 Encryption and Transmission

After the video is compressed, the provider encrypts it to keep people from accessing it for free. Encryption scrambles the digital data in such a way that it can only be **decrypted** (converted back into usable data) if the receiver has the correct decryption algorithm and security keys.

Once the signal is compressed and encrypted, the broadcast center beams it directly to one of its satellites. The satellite picks up the signal with an onboard dish, amplifies the signal and uses another dish to beam the signal back to Earth, where viewers can pick it up.

In the next section, we'll see what happens when the signal reaches a viewer's house.

4.7.2 Video and Audio Compression

Video and Audio files are very large beasts. Unless we develop and maintain very high bandwidth networks (Gigabytes per second or more) we have to compress to data.

Relying on higher bandwidths is not a good option -- M25 Syndrome: Traffic needs ever increases and will adapt to swamp current limit whatever this is.

As we will compression becomes part of the representation or *coding* scheme which have become popular audio, image and video formats.

We will first study basic compression algorithms and then go on to study some actual coding formats.

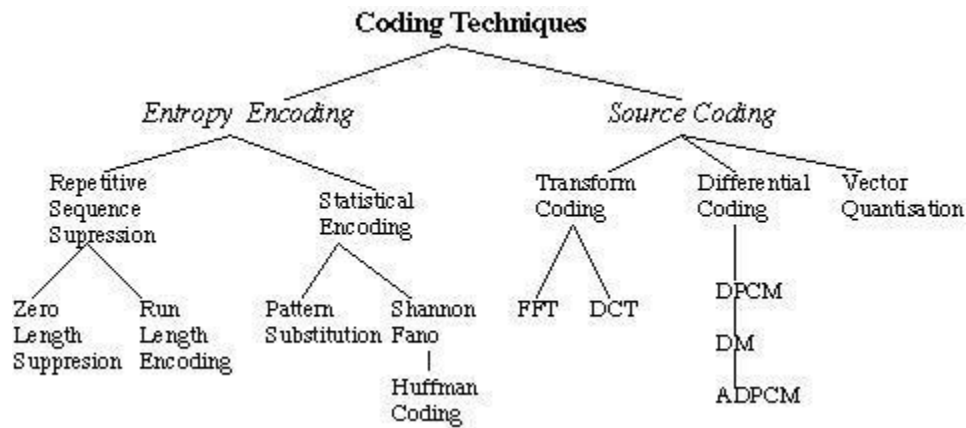

Figure 4.14 coding scheme

What is Compression?

Compression basically employs redundancy in the data:

- Temporal -- in 1D data, 1D signals, Audio etc.
- Spatial -- correlation between neighbouring pixels or data items
- Spectral -- correlation between colour or luminescence components. This uses the frequency domain to exploit relationships between frequency of change in data.
- psycho-visual -- exploit perceptual properties of the human visual system.

Compression can be categorized in two broad ways:

Lossless Compression

-- where data is compressed and can be reconstituted (uncompressed) without loss of detail or information. These are referred to as bit-preserving or reversible compression systems also.

Lossy Compression

-- where the aim is to obtain the best possible *fidelity* for a given bit-rate or minimizing the bit-rate to achieve a given fidelity measure. Video and audio compression techniques are most suited to this form of compression.

If an image is compressed it clearly needs to be uncompressed (decoded) before it can be viewed/listened to. Some processing of data may be possible in encoded form however. Lossless compression frequently involves some form of *entropy encoding* and are based in information theoretic techniques.

Lossy compression uses source encoding techniques that may involve transform encoding, differential encoding or vector quantization.

4.7.3 MPEG Standards

All MPEG standards exist to promote system interoperability among your computer, television and handheld video and audio devices. They are:

- **MPEG-1:** the original standard for encoding and decoding streaming video and audio files.
- **MPEG-2:** the standard for digital television, this compresses files for transmission of high-quality video.
- **MPEG-4:** the standard for compressing high-definition video into smaller-scale files that stream to computers, cell phones and PDAs (personal digital assistants).
- **MPEG-21:** also referred to as the Multimedia Framework. The standard that interprets what digital content to provide to which individual user so that media plays flawlessly under any language, machine or user conditions.

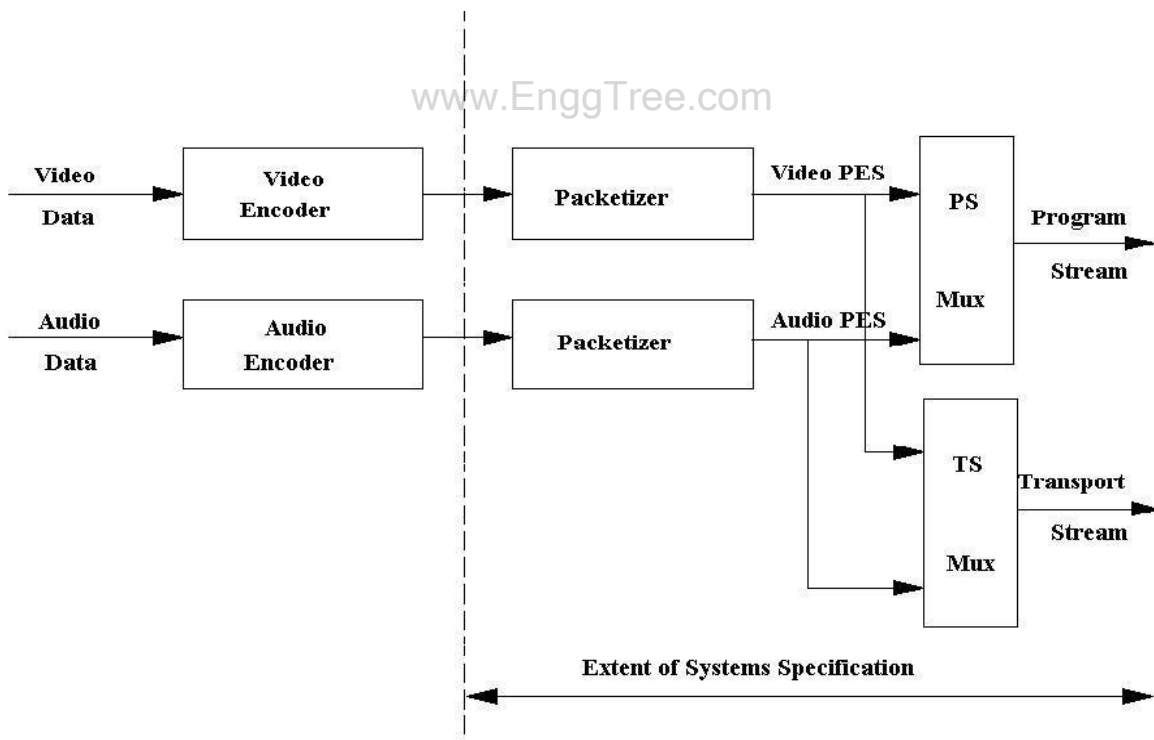

Figure 4.15 MPEG scheme

4.8 Encryption

It is the most effective way to achieve data security. To read an **encrypted** file, you must have access to a secret key or password that enables you to decrypt it. Unencrypted data is called **plain text** ; **encrypted** data is referred to as **cipher text**.

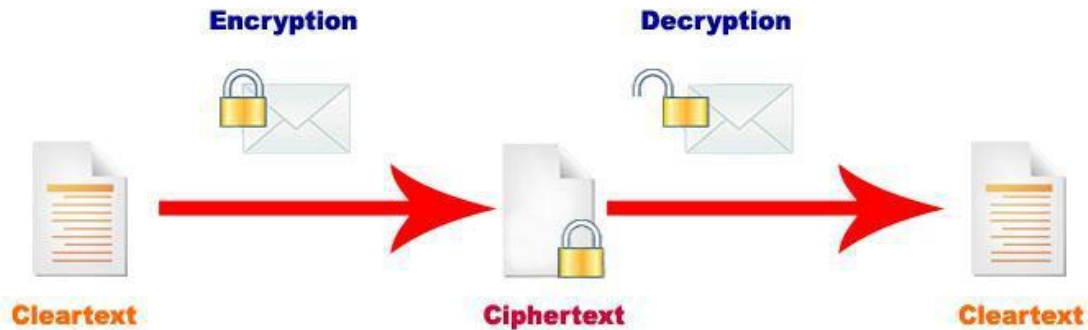

Figure 4.16 Encryption methods

www.EnggTree.com

4.8.1 Symmetric key encryption

In symmetric-key schemes, the encryption and decryption keys are the same. Thus communicating parties must have the same key before they can achieve secret communication.

In public-key encryption schemes, the encryption key is published for anyone to use and encrypt messages. However, only the receiving party has access to the decryption key that enables messages to be read.

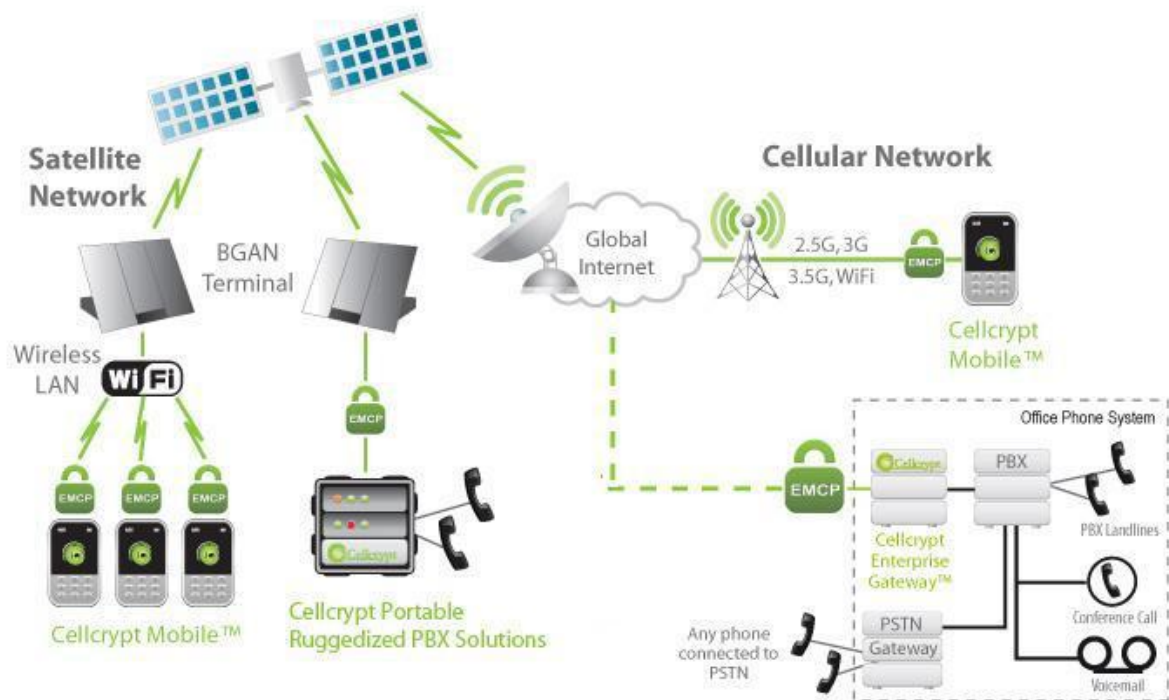

Figure 4.17 General block diagram Encryption methods

4.8.2 Decryption

www.EnggTree.com

It is the process of taking encoded or encrypted text or other data and converting it back into text that you or the computer are able to read and understand.

This term could be used to describe a method of un-encrypting the data manually or with un-encrypting the data using the proper codes or keys.

Data may be encrypted to make it difficult for someone to steal the information. Some companies also encrypt data for general protection of company data and trade secrets. If this data needs to be viewable, it may require decryption.

APPLICATIONS

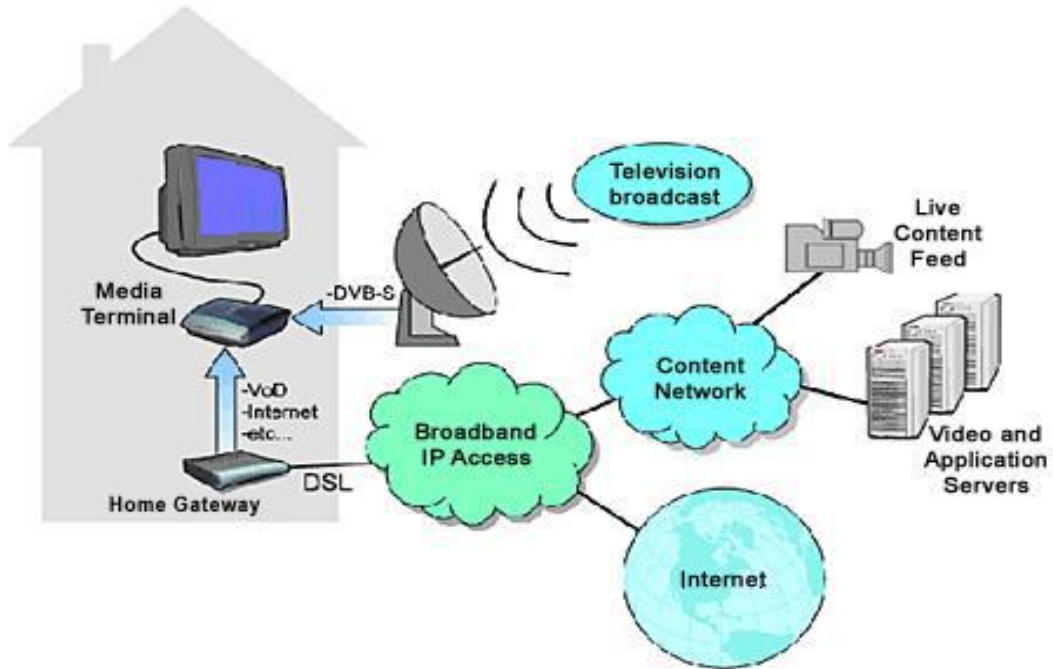

Figure an example of Digital video Broadcast

www.EnggTree.com

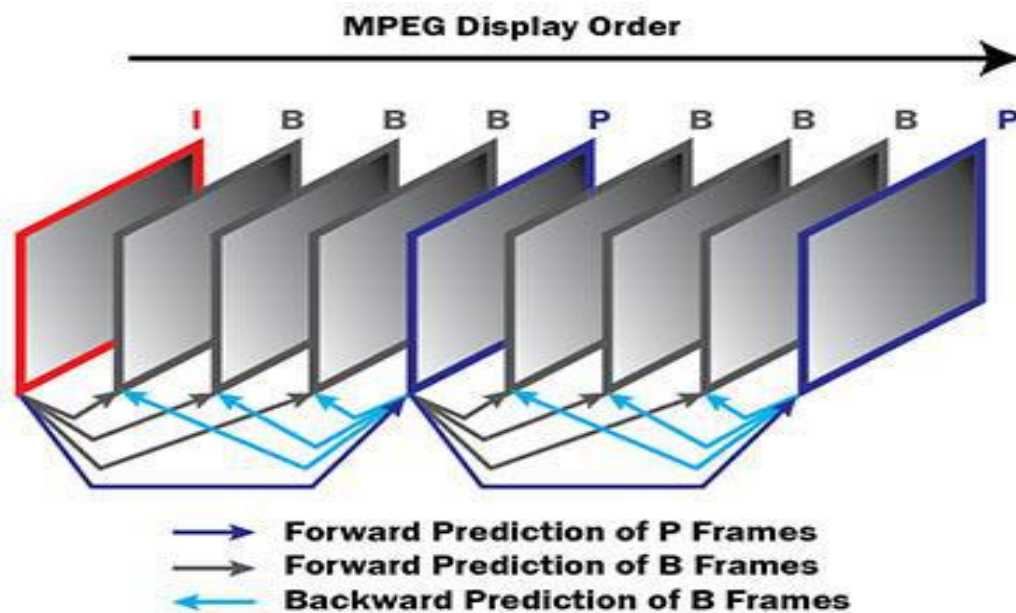

Figure an example of streaming video and compression

POST TEST MCQ

1. In a communication satellite, the telephone channels are assembled in
 - a) AM
 - b) FM
 - c) TDM
 - d) FDM**

2. The 24-MHz bandwidth of a transponder is capable of carrying _____
 - a) One analog television channel**
 - b) Two analog television channel
 - c) Four analog television channel
 - d) None of these

3. In DBS systems
 - a) MPEG-2 is used for video compression**
 - b) MPEG-2 is used for video enhancing
 - c) MPEG-2 is used for audio compression
 - d) None of these

4. 4:4:4 Sampling means that _____
 - a) The sampling rates of Y, Cb, and Cr are equal**
 - b) The sampling rates of Y, Cb, and Cr are unequal
 - c) a & b
 - d) None of these

5. A macro-block consists of _____
 - a) 16 * 16 pixels.**
 - b) 8 * 8 pixels.
 - c) 2 * 2 pixels .
 - d) None of these.

6. MPEG stands as_____.

- a) **Moving Pictures Expert Group**
- b) Most Pictures Expert Group
- c) Moving Pictures Enhance Group
- d) Motor Piston Expert Group

7. The bit rate for digital television depends very much on the_____.

- a) **Picture format**
- b) Information format
- c) Voice format
- d) None of these In DBS systems

8. MPEG-2 uses

- a) **4:2:0 sampling**
- b) 2:0:0 sampling
- c) 3:2:0 sampling
- d) 0:0:9 sampling

www.EnggTree.com

9. The multiple access technique suitable only for digital transmission is

- a) Packet Access
- b) CDMA
- c) FDMA
- d) **TDMA**

10. MPEG-4 provides the major advantage is the _____in bit rate offered in satellite television.

- a) **Reduction**
- b) Increment
- c) double
- d) Triple

11. The most popular access method is _____, which allows the use of comparatively low-power VSAT terminals

- a) **FDMA**
- b) TDMA
- c) CDMA
- d) TDD

12. The uplink Frequency of C-band?

- a) 4GHz
- b) **6GHz**
- c) 8GHz
- d) 12GHz

13. Using the HDTV format having a pixel count per frame of _____ and a refresh rate of 30 frames per second

- a) $192 * 108$
- b) **$1920 * 1080$**
- c) $920 * 1000$
- d) $148 * 156$

www.EnggTree.com

14. Identify which of the following is a type of CDMA.

- a) Spread spectrum multiple access
- b) pulse address multiple access
- c) **both a&b**
- d) None of above

15. VSAT stands as _____.

- a) **Very small aperture terminal system**
- b) Vast small aperture terminal system
- c) Virtual small aperture terminal system
- d) Video small aperture terminal system

CONCLUSION

1. In this unit we discussed the Modulation and Multiplexing.
2. The multiple access: FDMA, TDMA, CDMA was discussed.
3. The compression – encryption were discussed.

REFERENCES

1. Wilbur L.Pritchard, Hendri G. Suyderhoud, Robert A. Nelson, “Satellite Communication Systems Engineering”, Prentice Hall/Pearson, 2007.
2. N. Agarwal, “Design of Geosynchronous Space Craft”, Prentice Hall, 1986.
3. Bruce R. Elbert, “Satellite Communication Applications”, Hand Book, Artech House Bostan London,1997.
4. Tri T. Ha, “Digital Satellite Communication”, II nd edition, 1990.
5. Robert G. Winch, “Telecommunication Transmission Systems”, Mc Graw-Hill Book Co., 1983.
6. Brian Ackroyd, “World Satellite Communication and earth station Design”, BSP professional Books, 1990.
7. G.B.Bleazard, “Introducing Satellite communications“, NCC Publication, 1985.
8. M.Richharia, “Satellite Communication Systems-Design Principles”, Macmillan 2003.
9. Emanuel Fthenakis, “Manual of Satellite Communications”, Mc Graw Hill Book Co., 1984.

ASSIGNMENT

1. Distinguish single access and multiple accesses.
2. Compare the use of data compression and encryption in satellite communication.
3. Compare pre-assigned FDMA and demand-assigned FDMA.
4. Explain the following with respect to TDMA: Reference burst, preamble and post amble and carrier recovery.
5. Compare the uplink power requirements of FDMA and TDMA.
6. Explain principles of Code-Division multiple Access.

SATELLITE COMMUNICATION

www.EnggTree.com

UNIT V SATELLITE APPLICATIONS

UNIT V SATELLITE APPLICATIONS

AIM & OBJECTIVE

- ❖ To understand the applications of satellites.
- ❖ To understand the Mobile satellite services.
- ❖ To understand the Video conferencing and Internet.

PRE -TEST MCQ

1. The familiar direct view cathode ray tube (CRT) used for analog TV is _____ of displaying HDTV.

- a) **Not capable**
- b) Capable
- c) Accept
- d) None of these

2. DirecTV plans to use _____ in its HDTV satellite broadcasts and all HDTV services in Europe are expected to use this rather than the MPEG-2.

- a) **H.264/AVC**
- b) H.24/AVC
- c) H.64/AVC
- d) H.456/AVC

3. The main factor governing performance of a DBS system will be the $[Eb/N_0]$ of the _____

- a) Uplink
- b) **Downlink**
- c) Up-downlink
- d) None of these

THEORY

5.1 INTELSAT Series

INTELSAT stands for *International Telecommunications Satellite*. The organization was created in 1964 and currently has over 140 member countries and more than 40 investing entities (see <http://www.intelsat.com/> for more details).

In July 2001 INTELSAT became a private company and in May 2002 the company began providing end-to-end solutions through a network of teleports, leased fiber, and *points of presence* (PoPs) around the globe.

Starting with the Early Bird satellite in 1965, a succession of satellites has been launched at intervals of a few years. Figure 1.1 illustrates the evolution of some of the INTELSAT satellites. As the figure shows, the capacity, in terms of number of voice channels, increased dramatically with each succeeding launch, as well as the design lifetime.

These satellites are in *geostationary orbit*, meaning that they appear to be stationary in relation to the earth. At this point it may be noted that geostationary satellites orbit in the earth's equatorial plane and their position is specified by their longitude.

For international traffic, INTELSAT covers three main regions—the *Atlantic Ocean Region* (AOR), the *Indian Ocean Region* (IOR), and the *Pacific Ocean Region* (POR) and what is termed *Intelsat America's Region*.

For the ocean regions the satellites are positioned in geostationary orbit above the particular ocean, where they provide a transoceanic telecommunications route. For example, INTELSAT satellite 905 is positioned at 335.5° east longitude.

The INTELSAT VII-VII/A series was launched over a period from October 1993 to June 1996. The construction is similar to that for the V and VA/VB series, shown in Fig. in that the VII series has solar sails rather than a cylindrical body.

The VII series was planned for service in the POR and also for some of the less demanding services in the AOR. The antenna beam coverage is appropriate for that of the POR. Figure 1.3 shows the antenna beam footprints for the C-band hemispheric coverage and zone coverage, as well as the spot beam coverage possible with the Ku-band antennas (Lilly, 1990; Sachdev et al., 1990).

When used in the AOR, the VII series satellite is inverted north for south (Lilly, 1990), minor adjustments then being needed only to optimize the antenna patterns for this region. The lifetime of these satellites ranges from 10 to 15 years depending on the launch vehicle.

Recent figures from the INTELSAT Web site give the capacity for the INTELSAT VII as 18,000 two-way telephone circuits and three TV channels; up to 90,000 two-way telephone circuits can be achieved with the use of “digital circuit multiplication.”

The INTELSAT VII/A has a capacity of 22,500 two-way telephone circuits and three TV channels; up to 112,500 two-way telephone circuits can be achieved with the use of digital circuit multiplication. As of May 1999, four satellites were in service over the AOR, one in the IOR, and two in the POR.

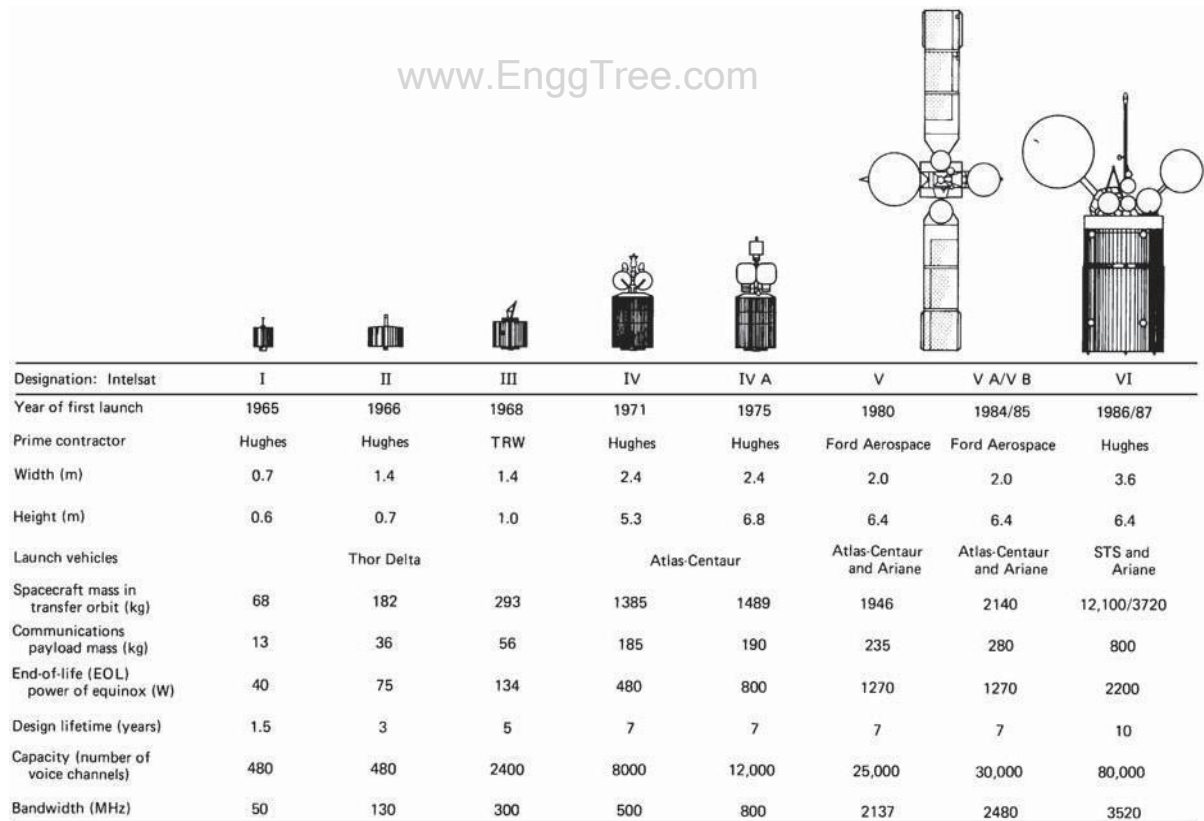

Figure 5.1 INTELSAT Series

The INTELSAT VIII-VII/A series of satellites was launched over the period February 1997 to June 1998. Satellites in this series have similar capacity as the VII/A series, and the lifetime is 14 to 17 years.

It is standard practice to have a spare satellite in orbit on high-reliability routes (which can carry preemptible traffic) and to have a ground spare in case of launch failure.

Thus the cost for large international schemes can be high; for example, series IX, described later, represents a total investment of approximately \$1 billion.

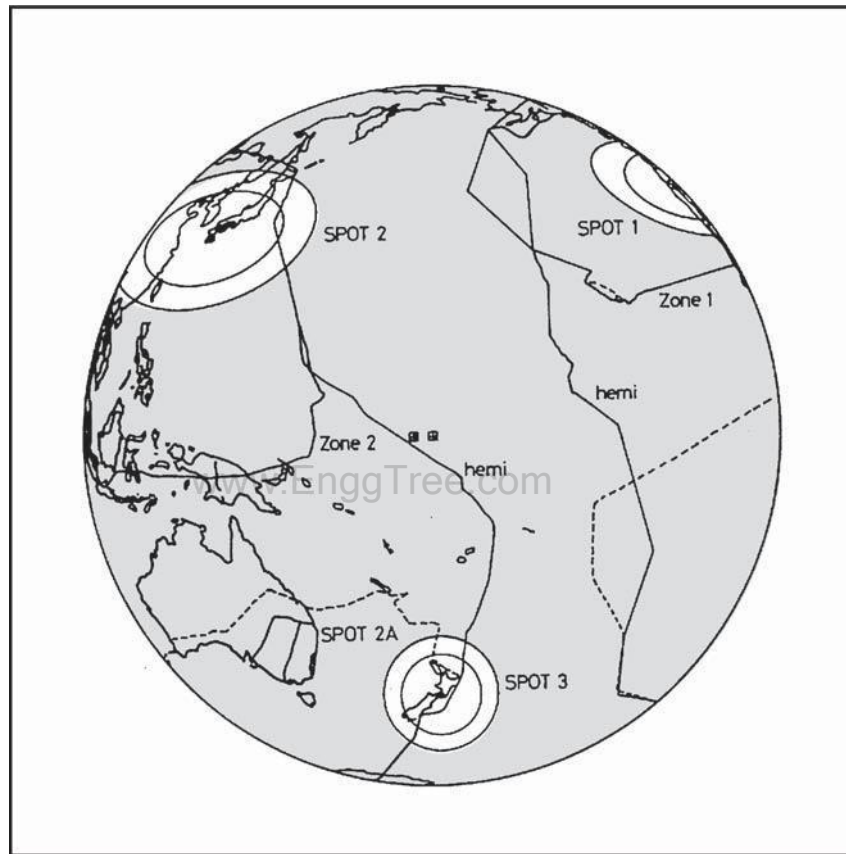

Figure 5.2 Region of glob

5.2 INSAT

INSAT or the *Indian National Satellite System* is a series of multipurpose geo-stationary satellites launched by ISRO to satisfy the telecommunications, broadcasting, meteorology, and search and rescue operations.

Commissioned in 1983, INSAT is the largest domestic communication system in the Asia Pacific Region. It is a joint venture of the Department of Space, Department of Telecommunications, India Meteorological Department,

All India Radio and Doordarshan. The overall coordination and management of INSAT system rests with the Secretary-level INSAT Coordination Committee.

INSAT satellites provide transponders in various bands (C, S, Extended C and Ku) to serve the television and communication needs of India. Some of the satellites also have the Very High Resolution Radiometer (VHRR), CCD cameras for metrological imaging.

The satellites also incorporate transponder(s) for receiving distress alert signals for search and rescue missions in the South Asian and Indian Ocean Region, as ISRO is a member of the Cospas-Sarsat programme.

5.2.1 INSAT System

The Indian National Satellite (INSAT) System Was Commissioned With The Launch Of INSAT-1B In August 1983 (INSAT-1A, The First Satellite Was Launched In April 1982 But Could Not Fulfil The Mission).

INSAT System Ushered In A Revolution In India's Television And Radio Broadcasting, Telecommunications And Meteorological Sectors. It Enabled The Rapid Expansion Of TV And Modern Telecommunication Facilities To Even The Remote Areas And Off-Shore Islands.

5.2.2 Satellites In Service

Of The 24 Satellites Launched In The Course Of The INSAT Program, 10 Are Still In Operation.INSAT-2E

It Is The Last Of The Five Satellites In INSAT-2 Series{Prateek }. It Carries Seventeen C-Band And Lower Extended C-Band Transponders Providing Zonal And Global Coverage With An Effective Isotropic Radiated Power (EIRP) Of 36 Dbw.

It Also Carries A Very High Resolution Radiometer (VHRR) With Imaging Capacity In The Visible (0.55-0.75 μm), Thermal Infrared (10.5-12.5 μm) And Water Vapour (5.7-7.1 μm) Channels And Provides 2x2 Km, 8x8 Km And 8x8 Km Ground Resolution Respectively.

INSAT-3A

The Multipurpose Satellite, INSAT-3A, Was Launched By Ariane In April 2003. It Is Located At 93.5 Degree East Longitude. The Payloads On INSAT-3A Are As Follows:

12 Normal C-Band Transponders (9 Channels Provide Expanded Coverage From Middle East To South East Asia With An EIRP Of 38 Dbw, 3 Channels Provide India Coverage With An EIRP Of 36 Dbw And 6 Extended C -Band Transponders Provide India Coverage With An EIRP Of 36 Dbw).

A CCD Camera Provides 1x1 Km Ground Resolution, In The Visible (0.63-0.69 μm), Near Infrared (0.77-0.86 μm) And Shortwave Infrared (1.55-1.70 μm) Bands.

INSAT-3D

Launched In July 2013, INSAT-3D Is Positioned At 82 Degree East Longitude. INSAT-3D Payloads Include Imager, Sounder, Data Relay Transponder And Search & Rescue Transponder. All The Transponders Provide Coverage Over Large Part Of The Indian Ocean Region Covering India, Bangladesh, Bhutan, Maldives, Nepal, Seychelles, Sri Lanka And Tanzania For Rendering Distress Alert Services

INSAT-3E

Launched In September 2003, INSAT-3E Is Positioned At 55 Degree East Longitude And Carries 24 Normal C-Band Transponders Provide An Edge Of Coverage EIRP Of 37 Dbw Over India And 12 Extended C-Band Transponders Provide An Edge Of Coverage EIRP Of 38 Dbw Over India.

KALPANA-1

KALPANA-1 Is An Exclusive Meteorological Satellite Launched By PSLV In September 2002. It Carries Very High Resolution Radiometer And DRT Payloads To Provide Meteorological Services. It Is Located At 74 Degree East Longitude. Its First Name Was METSAT. It Was Later Renamed As KALPANA-1 To Commemorate Kalpana Chawla.

Edusat

Configured For Audio-Visual Medium Employing Digital Interactive Classroom Lessons And Multimedia Content, EDUSAT Was Launched By GSLV In September 2004. Its Transponders And Their Ground Coverage Are Specially Configured To Cater To The Educational Requirements.

GSAT-2

Launched By The Second Flight Of GSLV In May 2003, GSAT-2 Is Located At 48 Degree East Longitude And Carries Four Normal C-Band Transponders To Provide 36 Dbw EIRP With India Coverage, Two K_u Band Transponders With 42 Dbw EIRP Over India And An MSS Payload Similar To Those On INSAT-3B And INSAT-3C.

INSAT-4 Series:

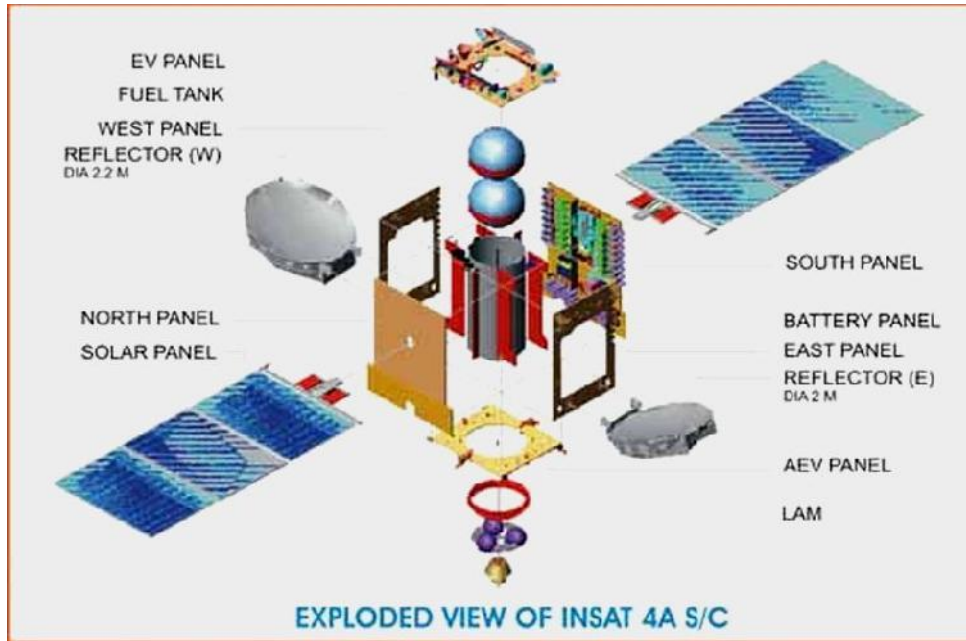

Figure 5.3 INSAT 4A

INSAT-4A is positioned at 83 degree East longitude along with INSAT-2E and INSAT-3B. It carries 12 K_u band 36 MHz bandwidth transponders employing 140 W TWTAs to provide an EIRP of 52 dBW at the edge of coverage polygon with footprint covering Indian main land and 12 C-band 36 MHz bandwidth transponders provide an EIRP of 39 dBW at the edge of coverage with expanded radiation patterns encompassing Indian geographical boundary, area beyond India in southeast and northwest regions.^[8] Tata Sky, a joint venture between the TATA Group and STAR uses INSAT-4A for distributing their DTH service.

- INSAT-4A
- INSAT-4B
- Glitch In INSAT 4B
- China-Stuxnet Connection
- INSAT-4CR
- GSAT-8 / INSAT-4G
- GSAT-12 /GSAT-10

5.3 VSAT

VSAT stands for *very small aperture terminal* system. This is the distinguishing feature of a VSAT system, the earth-station antennas being typically less than 2.4 m in diameter (Rana et al., 1990). The trend is toward even smaller dishes, not more than 1.5 m in diameter (Hughes et al., 1993).

In this sense, the small TVRO terminals for direct broadcast satellites could be labeled as VSATs, but the appellation is usually reserved for private networks, mostly providing two-way communications facilities.

Typical user groups include banking and financial institutions, airline and hotel booking agencies, and large retail stores with geographically dispersed outlets.

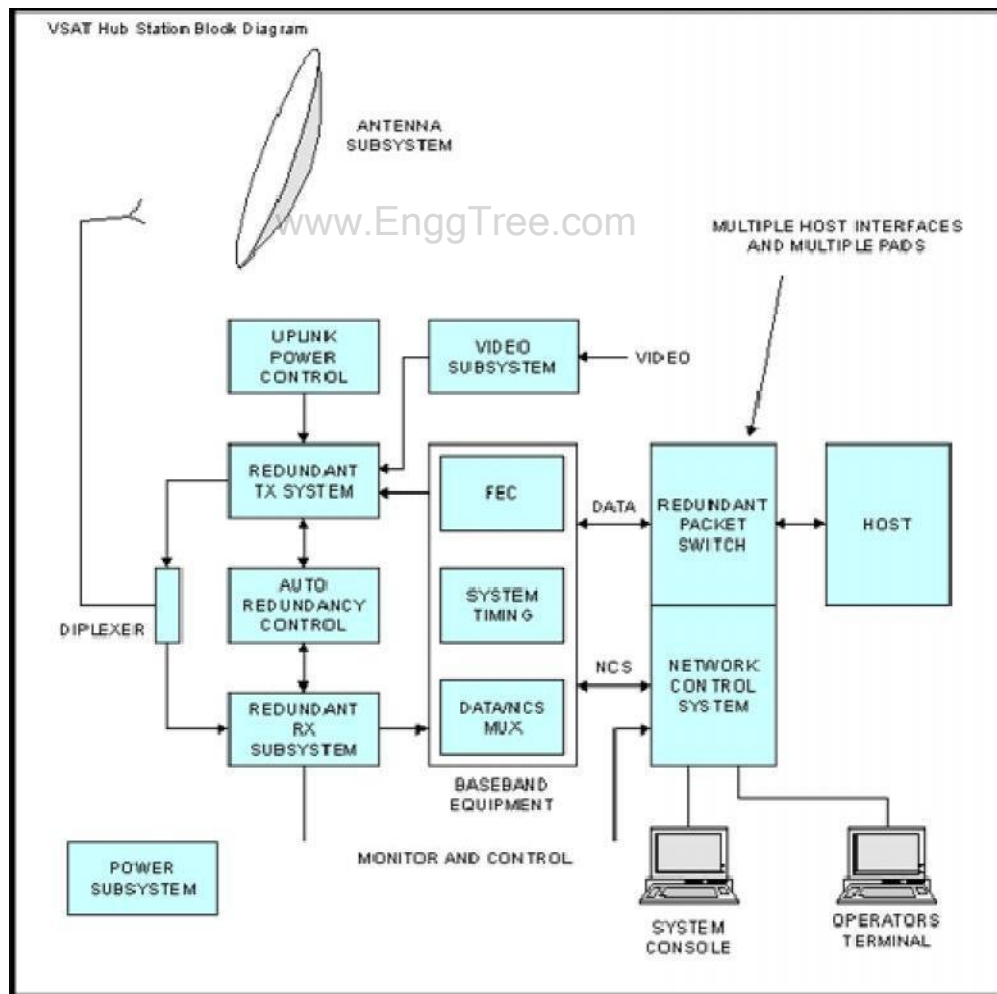

Figure 5.4 VSAT Block Diagrams

5.3.1 VSAT network

The basic structure of a VSAT network consists of a hub station which provides a broadcast facility to all the VSATs in the network and the VSATs themselves which access the satellite in some form of multiple-access mode.

The hub station is operated by the service provider, and it may be shared among a number of users, but of course, each user organization has exclusive access to its own VSAT network.

Time division multiplex is the normal downlink mode of transmission from hub to the VSATs, and the transmission can be broadcast for reception by all the VSATs in a network, or address coding can be used to direct messages to selected VSATs.

A form of *demand assigned multiple access* (DAMA) is employed in some systems in which channel capacity is assigned in response to the fluctuating demands of the VSATs in the network.

Most VSAT systems operate in the Ku band, although there are some C-band systems in existence (Rana et al., 1990).

5.3.2 Applications

- ✓ Supermarket shops (tills, ATM machines, stock sale updates and stock ordering). www.EnggTree.com
- ✓ Chemist shops - Shoppers Drug Mart - Pharmaprix. Broadband direct to the home. e.g. Downloading MP3 audio to audio players.
- ✓ Broadband direct small business, office etc, sharing local use with many PCs.
- ✓ Internet access from on board ship Cruise ships with internet cafes, commercial shipping communications.

5.4 Mobile satellite services

5.4.1 GSM

5.4.1.1 Services and Architecture

If your work involves (or is likely to involve) some form of wireless public communications, you are likely to encounter the GSM standards. Initially developed to support a standardized approach to digital cellular communications in Europe, the "Global System for Mobile Communications" (GSM) protocols are rapidly being adopted to the next generation of wireless telecommunications systems.

In the US, its main competition appears to be the cellular TDMA systems based on the IS-54 standards. Since the GSM systems consist of a wide range of components, standards, and protocols.

The GSM and its companion standard DCS1800 (for the UK, where the 900 MHz frequencies are not available for GSM) have been developed over the last decade to allow cellular communications systems to move beyond the limitations posed by the older analog systems.

Analog system capacities are being stressed with more users that can be effectively supported by the available frequency allocations. Compatibility between types of systems had been limited, if non-existent.

By using digital encoding techniques, more users can share the same frequencies than had been available in the analog systems. As compared to the digital cellular systems in the US (CDMA [IS-95] and TDMA [IS-54]), the GSM market has had impressive success. Estimates of the numbers of telephones run from 7.5 million GSM phones to .5 million IS54 phones to .3 million for IS95.

GSM has gained in acceptance from its initial beginnings in Europe to other parts of the world including Australia, New Zealand, countries in the Middle East and the far east. Beyond its use in cellular frequencies (900 MHz for GSM, 1800 MHz for DCS1800), portions of the GSM signaling protocols are finding their way into the newly developing PCS and LEO Satellite communications systems.

While the frequencies and link characteristics of these systems differ from the standard GSM air interface, all of these systems must deal with users roaming from one cell (or satellite beam) to another, and bridge services to public communication networks including the Public Switched Telephone Network (PSTN), and public data networks (PDN).

The GSM architecture includes several subsystems

The Mobile Station (MS) -- These digital telephones include vehicle, portable and hand-held terminals. A device called the Subscriber Identity Module (SIM) that is basically a smart-card provides custom information about users such as the services they've subscribed to and their identification in the network

The Base Station Sub-System (BSS) -- The BSS is the collection of devices that support the switching networks radio interface. Major components of the BSS include the Base Transceiver Station (BTS) that consists of the radio modems and antenna equipment.

In OSI terms, the BTS provides the physical interface to the MS where the BSC is responsible for the link layer services to the MS. Logically the transcoding equipment is in the BTS, however, an additional component.

The Network and Switching Sub-System (NSS) -- The NSS provides the switching between the GSM subsystem and external networks along with the databases used for additional subscriber and mobility management.

Major components in the NSS include the Mobile Services Switching Center (MSC), Home and Visiting Location Registers (HLR, VLR). The HLR and VLR databases are interconnected through the telecomm standard Signaling System 7 (SS7) control network.

The Operation Sub-System (OSS) -- The OSS provides the support functions responsible for the management of network maintenance and services. Components of the OSS are responsible for network operation and maintenance, mobile equipment management, and subscription management and charging.

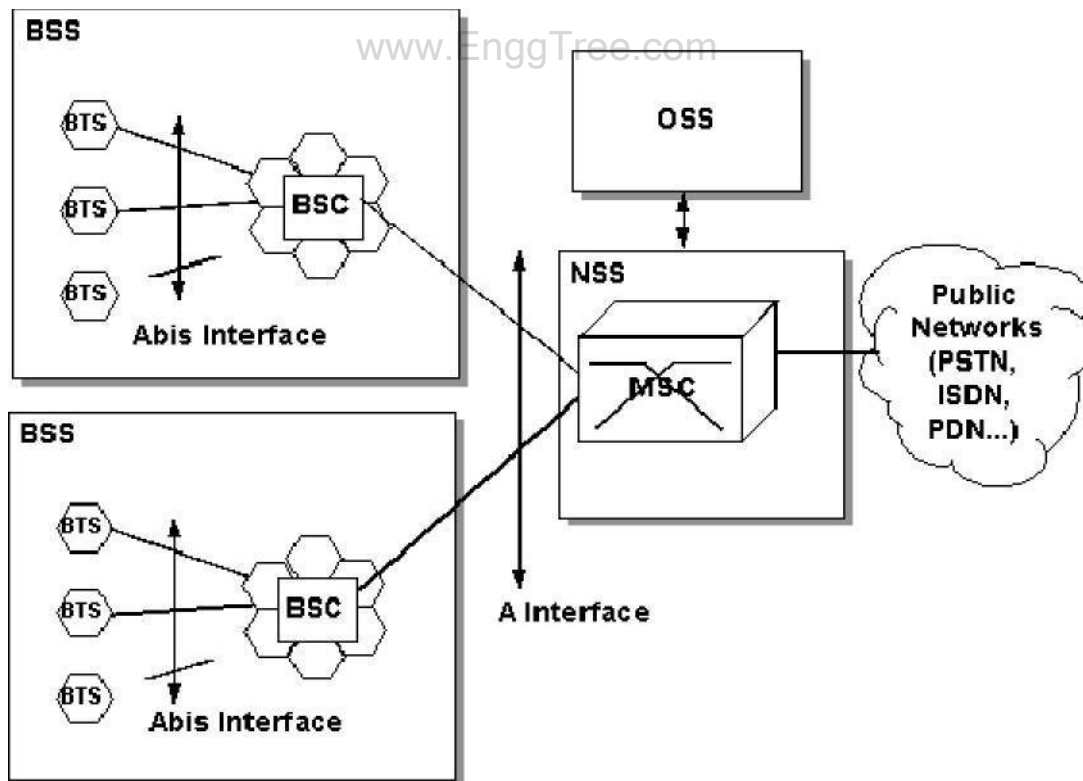

Figure 5.5 GSM Block Diagrams

Several channels are used in the air interface

- ✓ **FCCH** - the frequency correction channel - provides frequency synchronization information in a burst
- ✓ **SCH** - Synchronization Channel - shortly following the FCCH burst (8 bits later), provides a reference to all slots on a given frequency
- ✓ **PAGCH** - Paging and Access Grant Channel used for the transmission of paging information requesting the setup of a call to a MS.
- ✓ **RACH** - Random Access Channel - an inbound channel used by the MS to request connections from the ground network. Since this is used for the first access attempt by users of the network, a random access scheme is used to aid in avoiding collisions.
- ✓ **CBCH** - Cell Broadcast Channel - used for infrequent transmission of broadcasts by the ground network.
- ✓ **BCCH** - Broadcast Control Channel - provides access status information to the MS. The information provided on this channel is used by the MS to determine whether or not to request a transition to a new cell

- ✓ **FACCH** - Fast Associated Control Channel for the control of handovers
- ✓ **TCH/F** - Traffic Channel, Full Rate for speech at 13 kbps or data at 12, 6, or 3.6 kbps
- ✓ **TCH/H** - Traffic Channel, Half Rate for speech at 7 kbps, or data at 6 or 3.6 kbps

5.5 Mobility Management

One of the major features used in all classes of GSM networks (cellular, PCS and Satellite) is the ability to support roaming users. Through the control signaling network, the MSCs interact to locate and connect to users throughout the network.

"Location Registers" are included in the MSC databases to assist in the role of determining how, and whether connections are to be made to roaming users. Each user of a GSM MS is assigned a Home Location Register (HLR) that is used to contain the user's location and subscribed services.

Difficulties facing the operators can include

- a. Remote/Rural Areas. To service remote areas, it is often economically unfeasible to provide backhaul facilities (BTS to BSC) via terrestrial lines (fiber/microwave).

- b. Time to deploy. Terrestrial build-outs can take years to plan and implement.
- c. Areas of 'minor' interest. These can include small isolated centers such as tourist resorts, islands, mines, oil exploration sites, hydro-electric facilities.
- d. Temporary Coverage. Special events, even in urban areas, can overload the existing infrastructure.

5.5.1 GSM service security

GSM was designed with a moderate level of service security. GSM uses several cryptographic algorithms for security. The A5/1, A5/2, and A5/3 stream ciphers are used for ensuring over-the-air voice privacy.

GSM uses General Packet Radio Service (GPRS) for data transmissions like browsing the web. The most commonly deployed GPRS ciphers were publicly broken in 2011. The researchers revealed flaws in the commonly used GEA/1.

5.5.2 Global Positioning System (GPS)

The Global Positioning System (GPS) is a satellite based navigation system that can be used to locate positions anywhere on earth. Designed and operated by the U.S. Department of Defense, it consists of satellites, control and monitor stations, and receivers. GPS receivers take information transmitted from the satellites and uses triangulation to calculate a user's exact location. GPS is used on incidents in a variety of ways, such as:

- ✓ To determine position locations; for example, you need to radio a helicopter pilot the coordinates of your position location so the pilot can pick you up.
- ✓ To navigate from one location to another; for example, you need to travel from a lookout to the fire perimeter.
- ✓ To create digitized maps; for example, you are assigned to plot the fire perimeter and hot spots.
- ✓ To determine distance between two points or how far you are from another location.

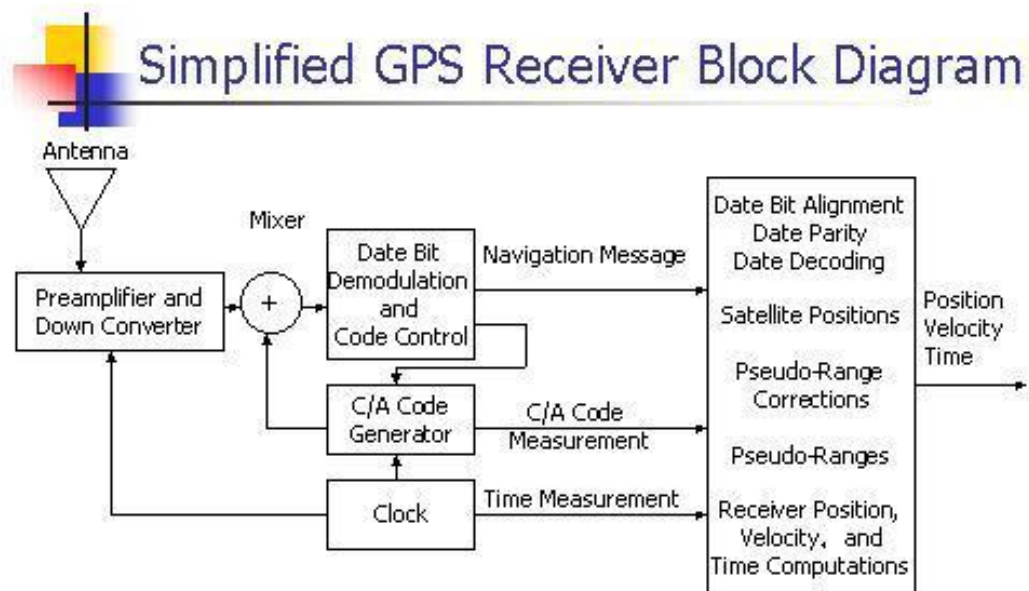

Figure 5.6 GPS Block Diagrams

The purpose of this chapter is to give a general overview of the Global Positioning System, not to teach proficiency in the use of a GPS receiver. To become proficient with a specific GPS receiver, study the owner's manual and practice using the receiver.

The chapter starts with a general introduction on how the global positioning system works. Then it discusses some basics on using a GPS receiver.

Three Segments of GPS:

Space Segment — Satellites orbiting the earth

The space segment consists of 29 satellites circling the earth every 12 hours at 12,000 miles in altitude. This high altitude allows the signals to cover a greater area. The satellites are arranged in their orbits so a GPS receiver on earth can receive a signal from at least four satellites at any given time. Each satellite contains several atomic clocks.

Control Segment — The control and monitoring stations

The control segment tracks the satellites and then provides them with corrected orbital and time information. The control segment consists of five unmanned monitor stations and one Master Control Station. The five unmanned stations monitor GPS satellite signals and then send that information to the Master Control Station where anomalies are corrected and sent back to the GPS satellites through ground antennas.

User Segment — The GPS receivers owned by civilians and military

The user segment consists of the users and their GPS receivers. The number of simultaneous users is limitless.

How GPS Determines a Position

The GPS receiver uses the following information to determine a position.

- ✓ Precise location of satellites
- ✓ When a GPS receiver is first turned on, it downloads orbit information from all the satellites called an almanac. This process, the first time, can take as long as 12 minutes; but once this information is downloaded, it is stored in the receiver's memory for future use.
- ✓ Distance from each satellite

The GPS receiver calculates the distance from each satellite to the receiver by using the distance formula: $\text{distance} = \text{velocity} \times \text{time}$. The receiver already knows the velocity, which is the speed of a radio wave or 186,000 miles per second (the speed of light).

- ✓ Triangulation to determine position

The receiver determines position by using triangulation. When it receives signals from at least three satellites the receiver should be able to calculate its approximate position (a 2D position). The receiver needs at least four or more satellites to calculate a more accurate 3D position.

Using a GPS Receiver

There are several different models and types of GPS receivers. Refer to the owner's manual for your GPS receiver and practice using it to become proficient.

- ✓ When working on an incident with a GPS receiver it is important to:
- ✓ Always have a compass and a map.
- ✓ Have a GPS download cable.
- ✓ Have extra batteries.
- ✓ Know memory capacity of the GPS receiver to prevent loss of data, decrease in accuracy of data, or other problems.
- ✓ Use an external antennae whenever possible, especially under tree canopy, in canyons, or while flying or driving.
- ✓ Set up GPS receiver according to incident or agency standard regulation; coordinate system.
- ✓ Take notes that describe what you are saving in the receiver.

www.EnggTree.com

5.6. INMARSAT

Inmarsat-Indian Maritime SATellite is still the sole IMO-mandated provider of satellite communications for the GMDSS.

- Availability for GMDSS is a minimum of 99.9%

Inmarsat has constantly and consistently exceeded this figure & Independently audited by IMSO and reported on to IMO.

Now Inmarsat commercial services use the same satellites and network & Inmarsat A closes at midnight on 31 December 2007 Agreed by IMO – MSC/Circ.1076. Successful closure programme almost concluded Overseen throughout by IMSO.

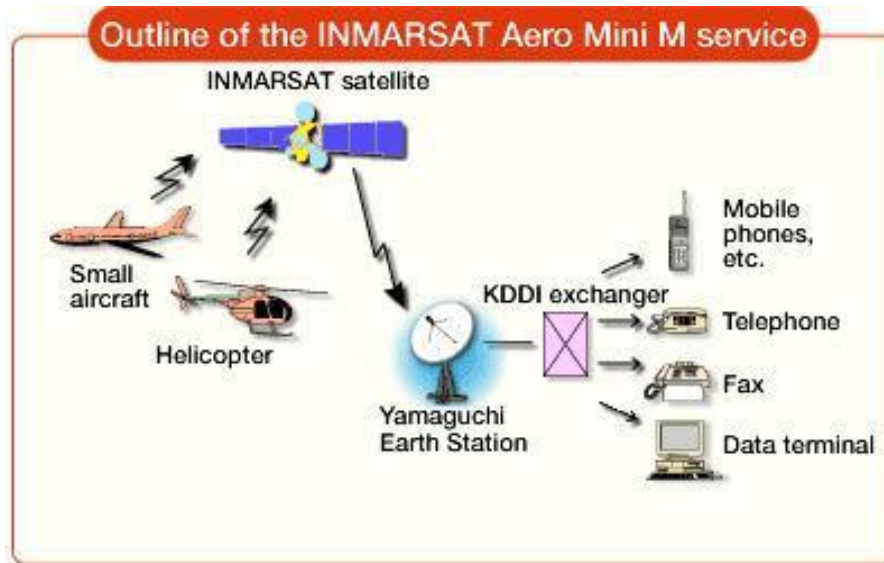

Figure 5.7 INMARSAT Satellite Service

GMDSS services continue to be provided by:

- Inmarsat B, Inmarsat C/mini-C and Inmarsat Fleet F77
 - Potential for GMDSS on FleetBroadband being assessed
- ➔ The IMO Criteria for the Provision of Mobile Satellite Communications Systems in the Global Maritime Distress and Safety System (GMDSS)
 - ➔ Amendments were proposed; potentially to make it simpler for other satellite systems to be approved
 - ➔ The original requirements remain and were approved by MSC 83
 - No dilution of standards
 - ➔ Minor amendments only; replacement Resolution expected to be approved by the IMO 25th Assembly
 - ➔ Inmarsat remains the sole, approved satcom provider for the GMDSS

5.7 LEO: Low Earth Orbit satellites have a small area of coverage. They are positioned in an orbit approximately 3000km from the surface of the earth

- They complete one orbit every 90 minutes
- The large majority of satellites are in low earth orbit
- The Iridium system utilizes LEO satellites (780km high)
- The satellite in LEO orbit is visible to a point on the earth for a very short time

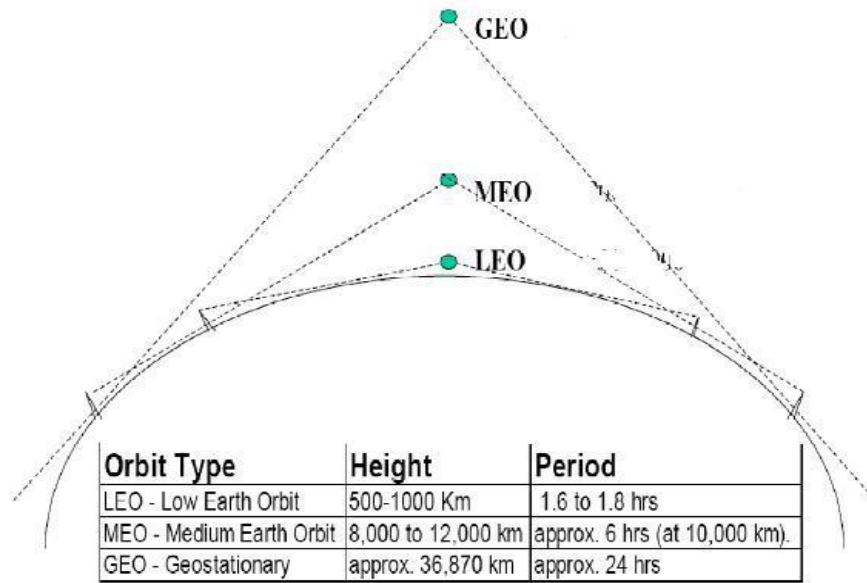

Figure 5.8 LEO, MEO & GEO range

5.8 MEO: *Medium Earth Orbit* satellites have orbital altitudes between 3,000 and 30,000 km.

- They are commonly used in navigation systems such as GPS

5.9 GEO: *Geosynchronous (Geostationary) Earth Orbit* satellites are positioned over the equator. The orbital altitude is around 30,000-40,000 km

- ⊙ There is only one geostationary orbit possible around the earth
 - Lying on the earth's equatorial plane.
 - The satellite orbiting at the same speed as the rotational speed of the earth on its axis.
 - They complete one orbit every 24 hours. This causes the satellite to appear stationary with respect to a point on the earth, allowing one satellite to provide continual coverage to a given area on the earth's surface
 - One GEO satellite can cover approximately 1/3 of the world's surface

They are commonly used in communication systems

- ⊙ Advantages:
 - Simple ground station tracking.
 - Nearly constant range
 - Very small frequency shift

- ⊙ Disadvantages:
 - Transmission delay of the order of 250 msec.
 - Large free space loss.
 - No polar coverage
- ⊙ Satellite orbits in terms of the orbital height:
- ⊙ According to distance from earth:
 - Geosynchronous Earth Orbit (GEO) ,
 - Medium Earth Orbit (MEO),
 - Low Earth Orbit (LEO)

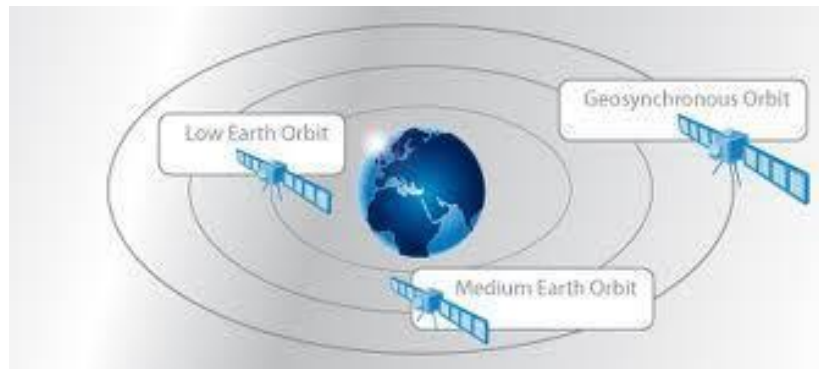

Figure 5.9 LEO, MEO & GEO Orbits



LEO / MEO / GEO / TEO (cont.)

	Name	Number	Panel	No./Panel	altitude	deg.
LEO	STARSYS	24	6	4	1300km	60
	ORBCOMM	24	4	6	785km	45
	GLOBALSTAR	48	8	6	1400km	52
	IRIDIUM	66	6	11	765km	86
MEO	INMARSAT P	10	2	5	10300km	45
	ODYSEEY	12	3	4	10370km	55
	GPS	24	6	4	20200km	55
	GLONASS	24	3	8	19132km	64.8
HEO	ELLIPSO	24	4	6	A: 7800km P: 520km	63.1
	MOLNIYA	4	1	4	A: 39863km P: 504km	63.4
	ARCHIMEDES	4	4	1	A: 39447km P: 926km	63.4

Figure 5.10 Diff b/w LEO, MEO & GEO Orbits

GEO: 35,786 km above the earth, MEO: 8,000-20,000 km above the earth & LEO: 500-2,000 km above the earth.

5.10 Satellite Navigational System: Benefits

- ❖ Enhanced Safety
- ❖ Increased Capacity
- ❖ Reduced Delays

Advantage

- Increased Flight Efficiencies
- Increased Schedule Predictability
- Environmentally Beneficial Procedures

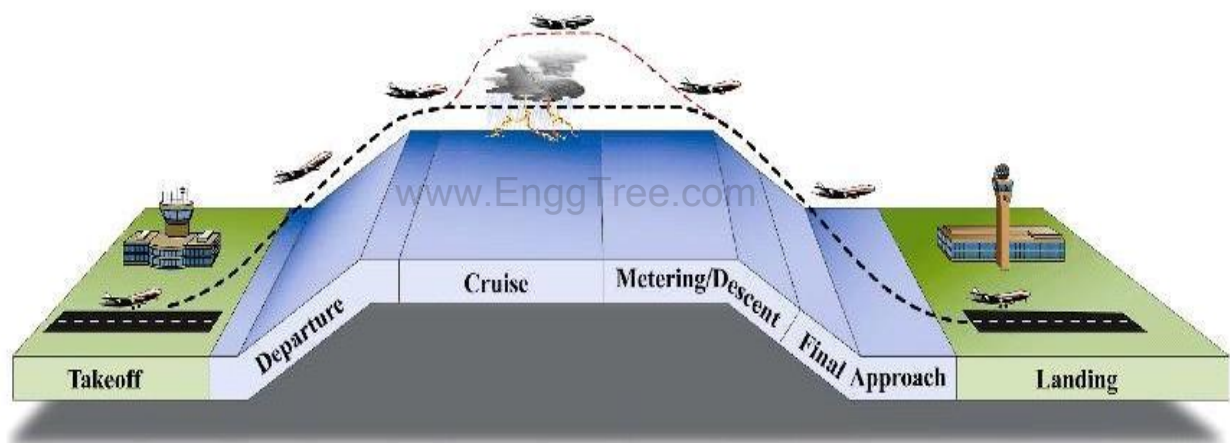

Figure 5.11 LEO, MEO & GEO Orbits

- Using ICAO GNSS Implementation Strategy and ICAO Standards and Recommended Practices
- GPS Aviation Use Approved for Over a Decade
 - Aircraft Based Augmentation Systems (ABAS) – (e.g. RAIM)
- Space Based Augmentation System (SBAS) since 2003
 - Wide Area Augmentation System (WAAS) augmenting GPS

Development of GNSS Ground Based Augmentation System (GBAS)
Continues

- Local Area Augmentation System (LAAS)

GNSS is Cornerstone for National Airspace System

5.11 Direct Broadcast satellites (DBS)

Satellites provide *broadcast* transmissions in the fullest sense of the word, because antenna footprints can be made to cover large areas of the earth.

The idea of using satellites to provide direct transmissions into the home has been around for many years, and the services provided are known generally as *direct broadcast satellite* (DBS) services.

Broadcast services include audio, television, and Internet services.

5.11.1 Power Rating and Number of Transponders

From Table 1.4 it will be seen that satellites primarily intended for DBS have a higher [EIRP] than for the other categories, being in the range 51 to 60 dBW. At a *Regional Administrative Radio Council* (RARC) meeting in 1983, the value established for DBS was 57 dBW (Mead,2000). Transponders are rated by the power output of their high-power amplifiers.

Typically, a satellite may carry 32 transponders. If all 32 are in use, each will operate at the lower power rating of 120 W.

The available bandwidth (uplink and downlink) is seen to be 500 MHz. A total number of 32 transponder channels, each of bandwidth 24 MHz, can be accommodated.

The bandwidth is sometimes specified as 27 MHz, but this includes a 3-MHz guard band allowance. Therefore, when calculating bit-rate capacity, the 24 MHz value is used.

The total of 32 transponders requires the use of both *right-hand circular polarization* (RHCP) and *left-hand circular polarization* (LHCP) in order to permit frequency reuse, and guard bands are inserted between channels of a given polarization.

	1	3	5	RHCP	31
Uplink MHz	17324.00	17353.16	17382.32	...	17761.40
Downlink MHz	12224.00	12253.16	12282.32	...	12661.40
	2	4	6	LHCP	32
Uplink MHz	17338.58	17367.74	17411.46	...	17775.98
Downlink MHz	12238.58	12267.74	12296.50	...	12675.98

Figure 5.12 DBS Service

5.11.2 Bit Rates for Digital Television

The bit rate for digital television depends very much on the picture format. One way of estimating the uncompressed bit rate is to multiply the number of pixels in a frame by the number of frames per second, and multiply this by the number of bits used to encode each pixel.

5.11.3 MPEG Compression Standards

MPEG is a group within the *International Standards Organization and the International Electrochemical Commission (ISO/IEC)* that undertook the job of defining standards for the transmission and storage of moving pictures and sound.

The MPEG standards currently available are MPEG-1, MPEG-2, MPEG-4, and MPEG-7.

5.12 Direct to home Broadcast (DTH)

DTH stands for Direct-To-Home television. DTH is defined as the reception of satellite programmes with a personal dish in an individual home.

- ✓ DTH Broadcasting to home TV receivers take place in the ku band(12 GHz). This service is known as Direct To Home service.
- ✓ DTH services were first proposed in India in 1996.
- ✓ Finally in 2000, DTH was allowed.
- ✓ The new policy requires all operators to set up earth stations in India

within 12 months of getting a license. DTH licenses in India will cost \$2.14 million and will be valid for 10 years.

Working principal of DTH is the satellite communication. Broadcaster modulates the received signal and transmit it to the satellite in KU Band and from satellite one can receive signal by dish and set top box.

5.12.1 DTH Block Diagram

- ✓ A DTH network consists of a broadcasting centre, satellites, encoders, multiplexers, modulators and DTH receivers
- ✓ The encoder converts the audio, video and data signals into the digital format and the multiplexer mixes these signals.

It is used to provide the DTH service in high populated area A Multi Switch is basically a box that contains signal splitters and A/B switches. A outputs of group of DTH LNBS are connected to the A and B inputs of the Multi Switch.

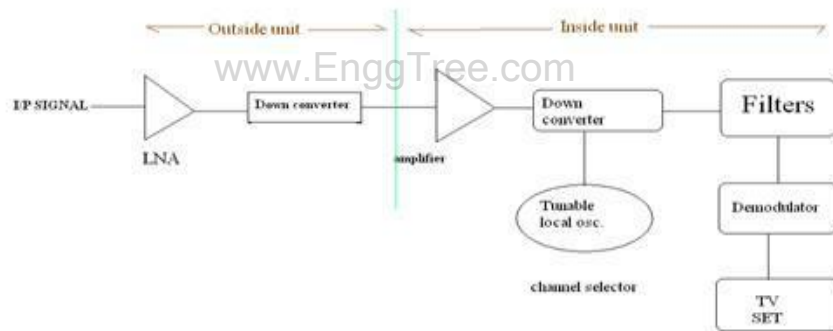

Figure 5.13 DTH Service

5.12.2 Advantage

- ✓ DTH also offers digital quality signals which do not degrade the picture or sound quality.
- ✓ It also offers interactive channels and program guides with customers having the choice to block out programming which they consider undesirable
- ✓ One of the great advantages of the cable industry has been the ability to provide local channels, but this handicap has been overcome by many

DTH providers using other local channels or local feeds.

- ✓ The other advantage of DTH is the availability of satellite broadcast in rural and semi-urban areas where cable is difficult to install.

5.13 Digital audio broadcast (DAB)

DAB Project is an industry-led consortium of over 300 companies

- ✓ The DAB Project was launched on 10th September, 1993
 - ✓ In 1995 it was basically finished and became operational
 - ✓ There are several sub-standards of the DAB standard
 - ❖ DAB-S (Satellite) – using QPSK – 40 Mb/s
 - ❖ DAB-T (Terrestrial) – using QAM – 50 Mb/s
 - ❖ DAB-C (Cable) – using OFDM – 24 Mb/s
 - ✓ These three sub-standards basically differ only in the specifications to the physical representation, modulation, transmission and reception of the signal.
- www.EnggTree.com
- ✓ The DAB stream consists of a series of fixed length packets which make up a Transport Stream (TS). The packets support 'streams' or 'data sections'.
 - ✓ Streams carry higher layer packets derived from an MPEG stream & Data sections are blocks of data carrying signaling and control data.
 - ✓ DAB is actually a support mechanism for MPEG.& One MPEG stream needing higher instantaneous data can 'steal' capacity from another with spare capacity.

5.14 World space services

World Space (Nasdaq: WRSP) is the world's only global media and entertainment company positioned to offer a satellite radio experience to consumers in more than 130 countries with five billion people, driving 300 million cars. World Space delivers the latest tunes, trends and information from around the world and around the corner.

World Space subscribers benefit from a unique combination of local programming, original World Space content and content from leading brands

around the globe, including the BBC, CNN, Virgin Radio, NDTV and RFI. World Space's satellites cover two-thirds of the globe with six beams.

Each beam is capable of delivering up to 80 channels of high quality digital audio and multimedia programming directly to World Space Satellite Radios anytime and virtually anywhere in its coverage area. World Space is a pioneer of satellite-based digital radio services (DARS) and was instrumental in the development of the technology infrastructure used today by XM Satellite Radio.

5.15 Business Television (BTV) - Adaptations for Education

Business television (BTV) is the production and distribution, via satellite, of video programs for closed user group audiences. It often has two-way audio interaction component made through a simple telephone line. It is being used by many industries including brokerage firms, pizza houses, car dealers and delivery services.

BTV is an increasingly popular method of information delivery for corporations and institutions. Private networks, account for about 70 percent of all BTV networks. It is estimated that by the mid-1990s BTV has the potential to grow to a \$1.6 billion market in North America with more and more Fortune 1,000 companies getting involved. The increase in use of BTV has been dramatic.

Institution updates, news, training, meetings and other events can be broadcast live to multiple locations. The expertise of the best instructors can be delivered to thousands of people without requiring trainers to go to the site. Information can be disseminated to all employees at once, not just a few at a time. Delivery to the workplace at low cost provides the access to training that has been denied lower level employees. It may be the key to re-training America's work force.

Television has been used to deliver training and information within businesses for more than 40 years. Its recent growth began with the introduction of the video cassette in the early 1970s. Even though most programming is produced for video cassette distribution, business is using BTV to provide efficient delivery of specialized programs via satellite.

The advent of smaller receiving stations - called very small aperture terminals (VSATs) has made private communication networks much more economical to operate. BTV has a number of tangible benefits, such as reducing travel, immediate delivery of time-critical messages, and eliminating cassette duplication and distribution hassles.

The programming on BTV networks is extremely cost-effective compared to seminar fees and downtime for travel. It is an excellent way to get solid and current information very fast. Some people prefer to attend seminars and

conferences where they can read, see, hear and ask questions in person. BTV provides yet another piece of the education menu and is another way to provide professional development.

A key advantage is that its format allows viewers to interact with presenters by telephone, enabling viewers to become a part of the program. The satellite effectively places people in the same room, so that sales personnel in the field can learn about new products at the same time.

Speed of transmission may well be the competitive edge which some firms need as they introduce new products and services. BTV enables employees in many locations to focus on common problems or issues that might develop into crises without quick communication and resolution.

BTV networks transmit information every business day on a broad range of topics, and provide instructional courses on various products, market trends, selling and motivation. Networks give subscribers the tools to apply the information they have to real world situations.

5.16 GRAMSAT

ISRO has come up with the concept of dedicated GRAMSAT satellites, keeping in mind the urgent need to eradicate illiteracy in the rural belt which is necessary for the all round development of the nation.

This Gramsat satellite is carrying six to eight high powered C-band transponders, which together with video compression techniques can disseminate regional and cultural specific audio-visual programmes of relevance in each of the regional languages through rebroadcast mode on an ordinary TV set.

The high power in C-band has enabled even remote area viewers outside the reach of the TV transmitters to receive programmes of their choice in a direct reception mode with a simple dish antenna.

The salient features of GRAMSAT projects are:

- i. Its communications networks are at the state level connecting the state capital to districts, blocks and enabling a reach to villages.
- ii. It is also providing computer connectivity data broadcasting, TV-broadcasting facilities having applications like e-governance, development information, teleconferencing, helping disaster management.
- iii. Providing rural-education broadcasting.

However, the Gramsat projects have an appropriate combination of following activities.

- (i) Interactive training at district and block levels employing suitable configuration
- (ii) Broadcasting services for rural development
- (iii) Computer interconnectivity and data exchange services
- (iv) Tele-health and tele-medicine services.

5.17 Specialized services

5.17.1 Satellite-email services

The addition of Internet Access enables Astrium to act as an Internet Service Provider (ISP) capable of offering Inmarsat users a tailor-made Internet connection.

With Internet services added to our range of terrestrial networks, you will no longer need to subscribe to a third party for Internet access (available for Inmarsat A, B, M, mini-M, Fleet, GAN, Regional BGAN & SWIFT networks).

We treat Internet in the same way as the other terrestrial networks we provide, and thus offer unrestricted access to this service. There is no time-consuming log-on procedure, as users are not required to submit a user-ID or password.

Description of E-mail Service

Astrium's E-Mail service allows Inmarsat users to send and receive e-mail directly through the Internet without accessing a public telephone network.

Features and Benefits

- ✓ No need to configure an e-mail client to access a Astrium e-mail account
- ✓ Service optimized for use with low bandwidth Inmarsat terminals
- ✓ Filter e-mail by previewing the Inbox and deleting any unwanted e-mails prior to downloading
- ✓ No surcharge or monthly subscription fees
- ✓ Service billed according to standard airtime prices for Inmarsat service used

5.17.2 Video Conferencing (medium resolution)

Video conferencing technology can be used to provide the same full, two-way interactivity of satellite broadcast at much lower cost. For Multi-Site meetings, video conferencing uses bridging systems to connect each site to the others.

It is possible to configure a video conference bridge to show all sites at the same time on a projection screen or monitor. Or, as is more typical, a bridge can show just the site from which a person is speaking or making a presentation.

The technology that makes interactive video conferencing possible, compresses video and audio signals, thus creating an image quality lower than that of satellite broadcasts.

5.17.3. Satellite Internet access

Satellite Internet access is Internet access provided through communications satellites. Modern satellite Internet service is typically provided to users through geostationary satellites that can offer high data speeds, with newer satellites using Ka band to achieve downstream data speeds up to 50 Mbps.

Satellite Internet generally relies on three primary components: a satellite in geostationary orbit (sometimes referred to as a geosynchronous Earth orbit, or GEO), a number of ground stations known as gateways that relay Internet data to and from the satellite via radio waves (microwave), and a VSAT (very-small-aperture terminal) dish antenna with a transceiver, located at the subscriber's premises.

Other components of a satellite Internet system include a modem at the user end which links the user's network with the transceiver, and a centralized network operations center (NOC) for monitoring the entire system.

APPLICATIONS



Figure example of INSAT -3 satellites

www.EnggTree.com



Figure example of Weather forecasting satellite

Post Test MCQ

1. The INTELSAT VI satellite used _____.

a) The INTELSAT VI satellite used heaters to maintain propulsion thrusters and line temperatures

b) With active attitude control, there is no overall stabilizing torque present to resist the disturbance torques

c) Proper moment

d) None of these

2. Teledesic satellites are _____ satellites.

a) GEO

b) MEO

c) LEO

d) none of the above

3. GPS satellites are _____ satellites.

a) GEO

b) MEO

c) LEO

d) none of the above

4. Low-Earth-orbit (LEO) satellites have _____ orbits

a) equatorial

b) polar

c) inclined

d) none of the above

5. MEO satellites are located at altitudes between km.

a) 3000 and 5000

b) 5000 and 10,000

c) 5000 and 15,000

d) 10 and 200

6. INTELSAT stands for

- a) **International Telecommunications Satellite**
- b) India Telecommunications Satellite
- c) Inter Telecommunications Satellite
- d) Italian Telemetry Satellite

7. What is application of satellite systems?

- a) **Weather forecasting**
- b) Terrestrial communication
- c) point to point communication
- d) Multipoint communication

8. Find out the service given by satellite systems.

- a) **Broadcasting satellite services**
- b) Signal transmission
- c) Information transmission
- d) None of the above

www.EnggTree.com

9. Universal time day is

- a) **UT day = $1/24(\text{hours} + \text{minutes}/60 + \text{seconds}/3600)$**
- b) UT day = $1/24(\text{hours} + \text{minutes} + \text{seconds}/3600)$
- c) UT day = $1/24(\text{hours} + \text{minutes}/6 + \text{seconds}/360)$
- d) UT day = $1/12(\text{hours} + \text{minutes}/6 + \text{seconds}/360)$

10. Identify the difference between the geodetic & geocentric latitudes.

- a) **The latitudes reaches a maximum at a geocentric latitude of 45deg, when the geodetic latitude is 45.192deg.**
- b) The latitudes reaches a maximum at a geocentric latitude of 30deg, when the geodetic latitude is 45.192deg.
- c) The latitudes reaches a maximum at a geocentric latitude of 45deg, when the geodetic latitude is 4.192deg.
- (d) No difference.

11. The Orbital Communications Corporation (Orbcomm) system is a _____, which provides two-way message and data communications services and position determination.

- a) MEO satellite system
- b) GEO satellite system
- c) LEO satellite system**
- d) None of these

12. The Orbital Communications Corporation (Orbcomm) system is a LEO satellite system, which provides _____ message and data communications services and position determination.

- a) Two-way**
- b) One-way
- c) Half-way
- d) None of these

13. The GPS system uses _____, from satellites to users, so that the user does not require a transmitter, only a GPS receiver.

- a) One-way transmissions**
- b) Two-way transmissions
- c) Half-way transmissions
- d) None of these

14. In the GPS system, a constellation of 24 satellites circles the earth in near-circular _____.

- a) GEO**
- (b) MEO
- c) Inclined orbits**
- d) None of these

CONCLUSION

- ❖ In this unit we discussed satellite applications.
- ❖ The Direct Broadcast satellites (DBS) and Direct to Home (DTH) Broadcast were discussed.
- ❖ The Video conferencing, Internet were discussed.

REFERENCES

1. Wilbur L.Pritchard, Hendri G. Suyderhoud, Robert A. Nelson, "Satellite Communication Systems Engineering", Prentice Hall/Pearson, 2007.
2. N. Agarwal, "Design of Geosynchronous Space Craft", Prentice Hall, 1986.
3. Bruce R. Elbert, "Satellite Communication Applications", Hand Book, Artech House Bostan London,1997.
4. Tri T. Ha, "Digital Satellite Communication", IInd edition, 1990.
5. Emanuel Fthenakis, "Manual of Satellite Communications", Mc Graw Hill Book Co., 1984.
www.EnggTree.com
6. Robert G. Winch, "Telecommunication Transmission Systems", Mc Graw-Hill Book Co., 1983.
7. Brian Ackroyd, "World Satellite Communication and earth station Design", BSP professional Books, 1990.
8. G.B.Bleazard, "Introducing Satellite communications", NCC Publication, 1985.
9. M.Richharia, "Satellite Communication Systems-Design Principles", Macmillan 2003.

ASSIGNMENT

1. Explain with the neat diagram the indoor and outdoor units of DBS home receiver.
2. Discuss the satellite mobile services.
3. Explain the following satellite applications.
 - i) GPS.
 - ii) Satellite Navigational system.
4. What are the major shortcomings of present day VAST system?
5. Write note on Bit rate for digital television.
6. List out the MPEG compression standards.
7. Explain detail about the VSAT.
8. What is meant by DTH? What are the design issues to be considered for launching DTH systems?
9. What is the orbital spacing of satellites?
10. Write brief notes on the advantages and disadvantages of using satellite in LEOs, MEOs and GEOs for mobile satellite communications.